

JVC



SEE
QUICK SET UP GUIDE
ON REAR SIDE



VIDEO CASSETTE RECORDER

HR-DD445EK

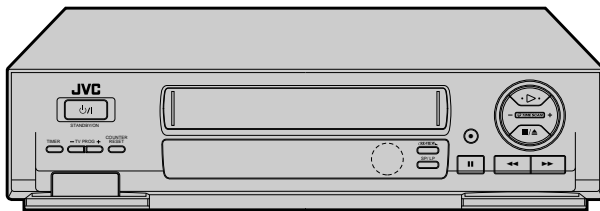
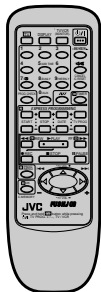

 **TIME SCAN**

VIDEO *Plus+*  **VHS**
PAL

INSTRUCTIONS

CONTENTS

SAFETY FIRST	2
Safety Precautions	2
Some Do's And Don'ts	3
INSTALLING YOUR NEW RECORDER 4	
Basic Connections	4
INITIAL SETTINGS	6
Video Channel Set	6
Auto Set Up	8
Video Plus+ Setup	10
PLAYBACK	12
Basic Playback	12
Playback Features	13
TimeScan	16
RECORDING	18
Basic Recording	18
Recording Features	19
B.E.S.T. Picture System	20
TIMER RECORDING	22
Video Plus+ Timer Recording ...	22
Regular Timer Programming	24
EDITING	28
Edit To Or From Another Video Recorder	28
Edit From A Camcorder	29
SYSTEM CONNECTIONS	30
Connection To A Satellite Receiver	30
SPECIAL FEATURES	32
TUNER SET	34
Auto Channel Set	34
Manual Channel Set	36
CLOCK SET	42
TROUBLESHOOTING	44
QUESTIONS AND ANSWERS	46
SPECIFICATIONS	47
INDEX	48

Safety Precautions

The rating plate and the safety caution are on the rear of the unit.

WARNING: DANGEROUS VOLTAGE INSIDE

WARNING: TO PREVENT FIRE OR SHOCK HAZARD, DO NOT EXPOSE THIS UNIT TO RAIN OR MOISTURE.

IMPORTANT

Connection to the mains supply in the United Kingdom. DO NOT cut off the mains plug from this equipment. If the plug fitted is not suitable for the power points in your home or the cable is too short to reach a power point, then obtain a proper safety approved extension lead/adaptor or consult your dealer.

BE SURE to replace the fuse only with an identical approved type, as originally fitted, and to replace the fuse cover.

If nonetheless the mains plug is cut off remove the fuse and dispose of the plug immediately, to avoid a possible shock hazard by inadvertent connection to the mains supply. If this product is not supplied fitted with a mains plug then follow the instructions given below:

DO NOT make any connection to the Larger Terminal coded E or Green.

The wires in the mains lead are coloured in accordance with the following code:

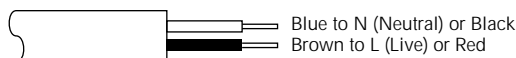

If these colours do not correspond with the terminal identifications of your plug, connect as follows:
Blue wire to terminal coded N (Neutral) or coloured Black.
Brown wire to terminal coded L (Live) or coloured Red.

If in doubt — consult a competent electrician.

CAUTION

- When you are not using the recorder for a long period of time, it is recommended that you disconnect the power cord from the mains outlet.
- Dangerous voltage inside. Refer internal servicing to qualified service personnel. To prevent electric shock or fire hazard, remove the power cord from the mains outlet prior to connecting or disconnecting any signal lead or aerial.

IMPORTANT

- Please read the various precautions on p. 2 – 3 of this instruction manual before installing or operating the recorder.
- It should be noted that it may be unlawful to re-record pre-recorded tapes, records, or discs without the consent of the owner of copyright in the sound or video recording, broadcast or cable programme and in any literary, dramatic, musical, or artistic work embodied therein.

The STANDBY/ON ϕ /I button does not completely shut off mains power from the unit, but switches operating current on and off. " ϕ " shows electrical power standby and " I " shows ON.

Video tapes recorded with this video recorder in the LP (Long Play) mode cannot be played back on a single-speed video recorder.

Failure to heed the following precautions may result in damage to the recorder, remote control or video cassette.

1. **DO NOT** place the recorder . . .
 - ... in an environment prone to extreme temperatures or humidity.
 - ... in direct sunlight.
 - ... in a dusty environment.
 - ... in an environment where strong magnetic fields are generated.
 - ... on a surface that is unstable or subject to vibration.
2. **DO NOT** block the recorder's ventilation openings.
3. **DO NOT** place heavy objects on the recorder or remote control.
4. **DO NOT** place anything which might spill on top of the recorder or remote control.
5. **AVOID** violent shocks to the recorder during transport.

MOISTURE CONDENSATION

Moisture in the air will condense on the recorder when you move it from a cold place to a warm place, or under extremely humid conditions—just as water droplets form in the surface of a glass filled with cold liquid. Moisture condensation on the head drum will cause damage to the tape. In conditions where condensation may occur, keep the recorder turned on for a few hours to let the moisture dry.

ABOUT HEAD CLEANING

Accumulation of dirt and other particles on the video heads may cause the playback picture to become blurred or interrupted. Be sure to contact your nearest JVC dealer if such troubles occur.



- Only cassettes marked "VHS" can be used with this videorecorder.
- HQ VHS is compatible with existing VHS equipment.
- Video Plus+ and PlusCode are trademarks of Gemstar Development Corporation. The Video Plus+ system is manufactured under license from Gemstar Development Corporation.

Some Do's And Don'ts On The Safe Use Of Equipment

This equipment has been designed and manufactured to meet international safety standards but, like any electrical equipment, care must be taken if you are to obtain the best results and safety is to be assured.

- DO** read the operating instructions before you attempt to use the equipment.
- DO** ensure that all electrical connections (including the mains plug, extension leads and interconnections between pieces of equipment) are properly made and in accordance with the manufacturer's instructions. Switch off and withdraw the mains plug when making or changing connections.
- DO** consult your dealer if you are ever in doubt about the installation, operation or safety of your equipment.
- DO** be careful with glass panels or doors on equipment.
- DON'T** continue to operate the equipment if you are in any doubt about it working normally, or if it is damaged in any way — switch off, withdraw the mains plug and consult your dealer.
- DON'T** remove any fixed cover as this may expose dangerous voltages.
- DON'T** leave equipment switched on when it is unattended unless it is specifically stated that it is designed for unattended operation or has a standby mode. Switch off using the switch on the equipment and make sure that your family knows how to do this. Special arrangements may need to be made for infirm or handicapped people.
- DON'T** use equipment such as personal stereos or radios so that you are distracted from the requirements of road safety. It is illegal to watch television whilst driving.
- DON'T** listen to headphones at high volume, as such use can permanently damage your hearing.
- DON'T** obstruct the ventilation of the equipment, for example with curtains or soft furnishings. Overheating will cause damage and shorten the life of the equipment.
- DON'T** use makeshift stands and NEVER fix legs with wood screws — to ensure complete safety always fit the manufacturer's approved stand or legs with the fixings provided according to the instructions.
- DON'T** allow electrical equipment to be exposed to rain or moisture.

ABOVE ALL...

- **NEVER** let anyone especially children push anything into holes, slots or any other opening in the case — this could result in a fatal electrical shock;
- **NEVER** guess or take chances with electrical equipment of any kind — it is better to be safe than sorry!

Basic Connections

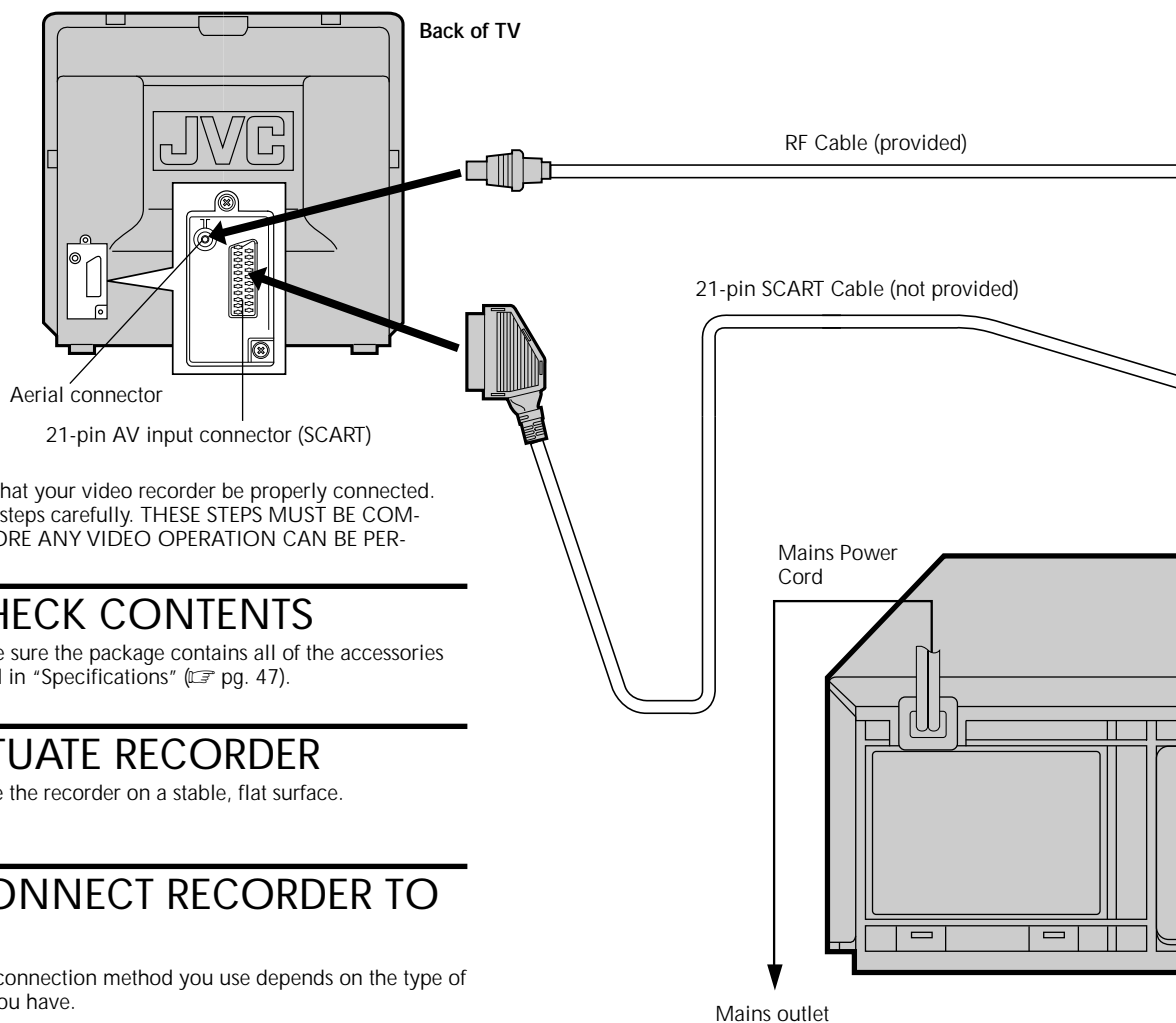

It's essential that your video recorder be properly connected. Follow these steps carefully. THESE STEPS MUST BE COMPLETED BEFORE ANY VIDEO OPERATION CAN BE PERFORMED.

1

CHECK CONTENTS

Make sure the package contains all of the accessories listed in "Specifications" (☞ pg. 47).

2

SITUATE RECORDER

Place the recorder on a stable, flat surface.

3

CONNECT RECORDER TO TV

The connection method you use depends on the type of TV you have.

RF CONNECTION

- To Connect To A TV With NO 21-pin AV input connector (SCART) . . .
 - a- Disconnect the TV aerial cable from the TV.
 - b- Connect the TV aerial cable to the ANT. IN jack on the rear panel of the recorder.
 - c- Connect the provided RF cable between the RF OUT jack on the rear panel of the recorder and the TV's aerial connector.

Before operating the recorder, make sure the TV's channel is set to the VIDEO channel (☞ pg. 6).

AV CONNECTION

- To Connect To A TV with 21-pin AV input connector (SCART) . . .
 - a- Connect the aerial, recorder and TV as per "RF CONNECTION".
 - b- Connect an optional SCART cable between the AV1 IN/OUT socket on the rear panel of the recorder and the TV's 21-pin AV input connector (SCART).

Before operating the recorder, make sure the TV is set to the VIDEO (or AV) mode.

4

CONNECT RECORDER TO MAINS

Plug the end of the mains power cord into a mains outlet.

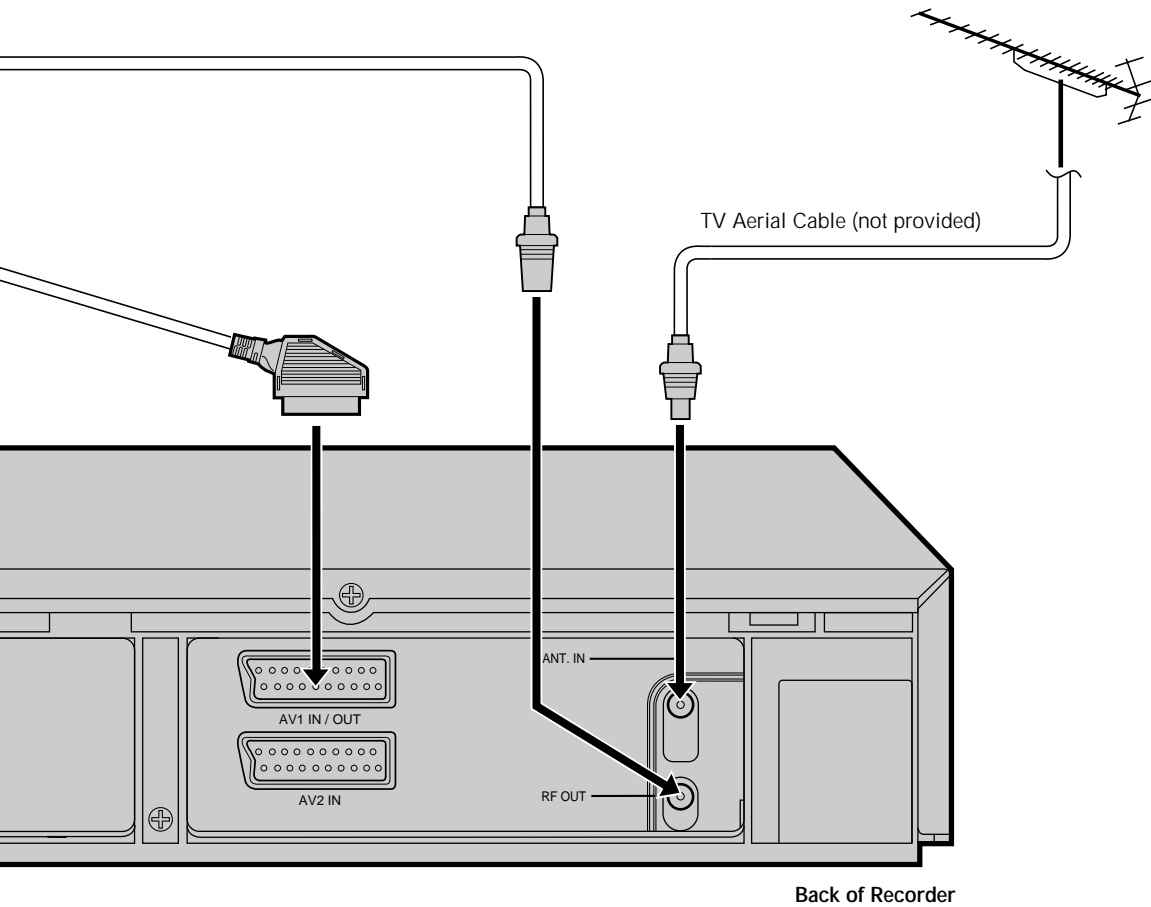
**ATTENTION**

If you have finished all the necessary connections, go to "Video Channel Set" on page 6, then perform Auto Set Up on page 8; do NOT press the ψ /I button on the recorder/remote control to turn on the recorder's power before you start Auto Set Up.

Video Channel Set

Video Channel (RF Output Channel) is the channel on which your TV receives picture and sound signals from the video recorder through the RF cable.

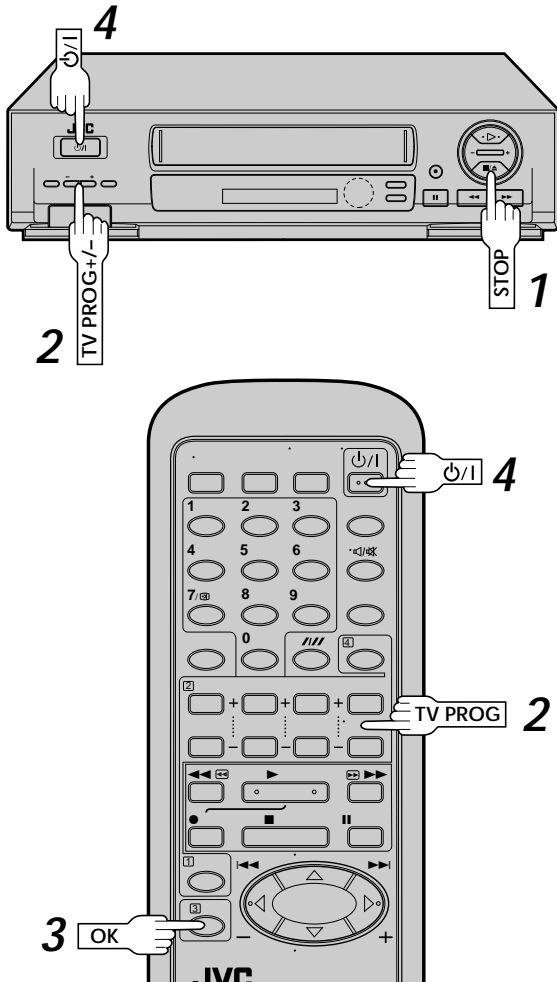

TEST SIGNAL

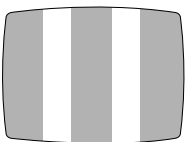

The channel on which the screen to the left appear clearly in step 2 is your Video Channel.

To view picture signals from the video recorder, set your TV to the Video Channel.

If you have connected the video recorder to your TV via the provided RF cable only (RF connection) – Go to "With RF Connection" below.

If you have connected the video recorder to your TV via both the provided RF cable and a 21-pin SCART cable (AV connection) – Go to "With AV Connection" on next page.

IMPORTANT:

Before performing the following steps, make sure the recorder's power is off and there is no cassette inserted in the recorder.

With RF Connection

ACCESS VIDEO CHANNEL SET MODE

Press and hold down **STOP** on the recorder until the display panel shows the following.



SET VIDEO CHANNEL

Set your TV to UHF channel 52. (Refer to the instructions supplied with your TV set for how to do this.)

- If the two vertical white bars appear clearly on the screen as shown in the illustration at bottom left, go to step 3.
- If the two vertical white bars do not appear clearly, press **TV PROG +** or **-** to set the video recorder to a vacant channel between 22 and 69 which is not occupied by any local station in your area. Refer to list on page 41 for details of broadcast stations in your area.

(Ex.) If channel 36 is available in your area



Then set your TV to UHF channel 36 and check if the two vertical white bars appear clearly on the screen; if so, go to step 3. If not, re-set the video recorder to another vacant channel and try again.

NOTES:

- If you set the video recorder to a channel which is occupied by a local station or has neighbouring channels that are occupied by local stations, the picture reception quality will be affected and some interference noise will appear on the TV screen. Be sure to select a vacant channel which has no broadcast on neighbouring channels.
- If you cannot obtain the two vertical white bars clearly with any channel between 22 and 69, consult your JVC dealer.

EXIT VIDEO CHANNEL SET MODE

Press **OK**.

TURN OFF THE RECORDER

Press **power**.

After you finish this step, go to "Auto Set Up" on page 8.

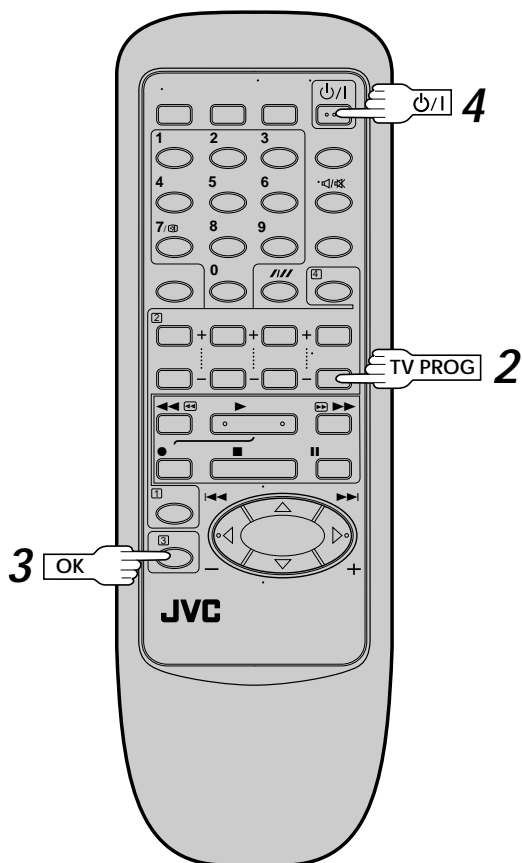
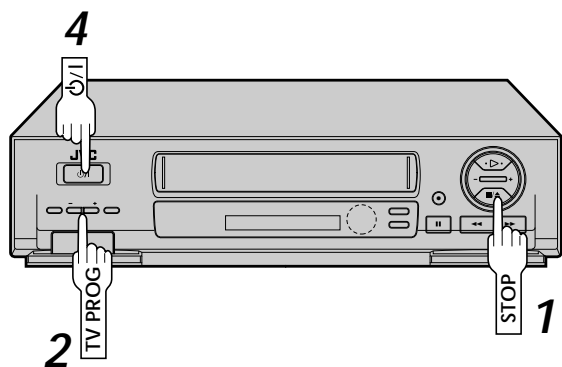
**IMPORTANT:**

Before performing the following steps, make sure the recorder's power is off and there is no cassette inserted in the recorder.

With AV Connection**1 ACCESS VIDEO CHANNEL SET MODE**

Press and hold down **STOP** on the recorder until the display panel shows the following.

**2 SET VIDEO CHANNEL**

Press **TV PROG** – until the display panel shows "_OUT--".



- Now the video channel is set to off.

3 EXIT VIDEO CHANNEL SET MODE

Press **OK**.

4 TURN OFF THE RECORDER

Press **power**.

To view picture signals from the video recorder, set your TV to its AV mode.

After you finish this step, go to "Auto Set Up" on page 8.

Auto Set Up

Auto Channel Set/Auto Clock Set/Auto Guide Program Number Set

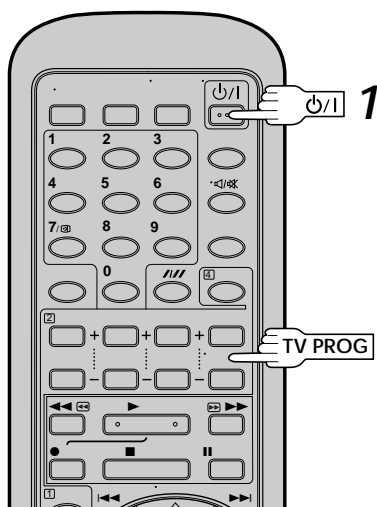
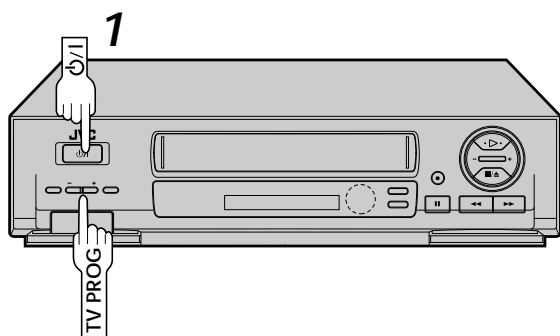

The Auto Set Up function sets the tuner channels, clock and Video Plus+ assigned Guide Program numbers automatically when the  button on the recorder/remote is first pressed to power on the recorder after you plug the mains power cord into a mains outlet.

Before starting the following procedure, make sure that the TV aerial cable is connected to the recorder and that the recorder's mains power cord is connected to a mains outlet (☞ pg.4).



PERFORM AUTO SET UP

1 Press  on the recorder or remote control.

"Auto" appears on the display panel and blinks; do NOT press any button on the recorder or remote control until the display panel shows the current time or "CH1" or "---:--". (Refer to box on page 9.) Auto Set Up usually takes about 4 – 12 minutes; the duration differs by the area.

- Auto channel set function takes place first; it assigns automatically all receivable stations in your area.
- Auto clock set function sets the clock automatically.
- During auto channel set, the recorder recognizes each station name of the detected stations and stores them in the recorder's memory, then automatically sets Video Plus+ assigned Guide Program number for those stations according to the broadcast area.

NOTES:

- If the TV power is on and its VIDEO channel or AV mode is selected during Auto Set Up, the AUTO SET screen will appear. As Auto Set Up progresses, the "■" mark on the screen moves from left to right.
- If there is a power cut, or if you press  or MENU while Auto Set Up is in progress, Auto Set Up will be interrupted; be sure to turn off the recorder power once and press  to turn the power back on to re-start Auto Set Up.

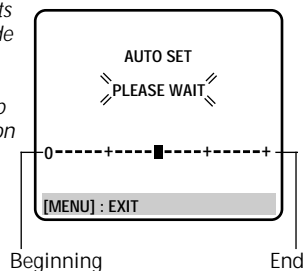

ATTENTION

Once you have performed Auto Set Up, even if the recorder's memory backup has expired, all the stored stations and their Guide Program numbers remain in the recorder's memory and the recorder will not perform Auto Set Up again. You only need to set the clock. (☞ pg. 42)

If you have moved to a different area, perform each setting as required.

- Tuner setting ☞ pg. 34
- Clock setting ☞ pg. 42
- Video Plus+ Guide Program number setting ☞ pg. 10

If a new station starts broadcasting in your area, perform both tuner setting (☞ pg. 34) and Video Plus+ Guide Program number setting (☞ pg. 10).

Auto Set Up results appear on the display panel

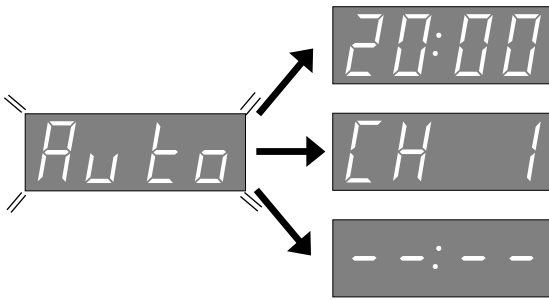

- When both auto channel set and auto clock set have been completed successfully the correct current time will be displayed.
- When auto channel set has been completed successfully but auto clock set has not, "CH" will be displayed.
- When neither auto channel set nor auto clock set has been completed successfully, "---:--" will be displayed.

* See "Video Plus+ Setup" on page 10 to check if the Guide Program numbers have been set correctly.

If both auto channel set and auto clock set have been performed successfully:

- 1 Turn on the TV and select its VIDEO channel or AV mode, then make sure that all necessary stations have been stored in the recorder's memory by using the **TV PROG** button(s).
 - If station names (ID — pg. 40) have also been stored in the recorder's memory, the station name will be displayed at the top left corner of the screen for about 5 seconds when the recorder is tuned to a different station.
 - If you want to set the tuner manually such as to add or skip channels, to change preset positions, or to set or change station names, see pages 36 – 39.
- 2 Perform "Video Plus+ Setup" on page 10 to check if the Guide Program numbers have been set correctly.

If auto channel set has succeeded but auto clock set has not:

- 1 Turn on the TV and select its VIDEO channel or AV mode, then make sure that all necessary stations have been stored in the recorder's memory by using the **TV PROG** button(s).
 - If station names (ID — pg. 40) have also been stored in the recorder's memory, the station name will be displayed at the top left corner of the screen for about 5 seconds when the recorder is tuned to a different station.
 - If you want to set the tuner manually such as to add or skip channels, to change preset positions, or to set or change station names, see pages 36 – 39.
- 2 Perform "Clock Set" on page 42, then "Video Plus+ Setup" on page 10 to check if the Guide Program numbers have been set correctly.

If both auto channel set and auto clock set have failed:

- 1 Make sure the TV aerial cable is connected properly to the recorder and turn off the recorder power once, then turn the recorder power back on again.
 - The recorder will try Auto Set Up again.

IMPORTANT

- Depending on the reception conditions, the station names may not be stored correctly, and auto Guide Program Number Set may not work properly. If the Guide Program numbers are not set properly, Video Plus+ timer recording (pg. 22) will not work correctly; be sure to check if the Guide Program numbers have been set correctly (pg. 10, "Video Plus+ Setup").
- Since your video recorder memorizes all detected stations even if the reception condition is poor, some of those stored stations may produce a noisy picture. To delete those stations, "Delete A Channel" on page 37.

Video Plus+ Setup

Turn on the TV and select the VIDEO channel (or AV mode).

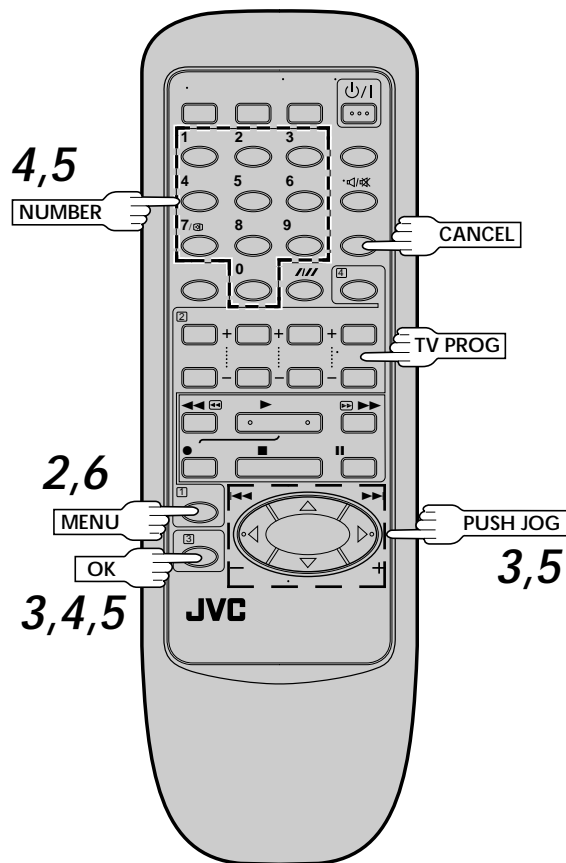

IMPORTANT

As Channel 5 has started its service on March 30th 1997, the Guide Program Numbers of some stations have been changed as follows:

Station Name	Guide Program Number	
	Before	Now
CHANNEL 5	—	5
RTE1 (IRELAND)	5	6
NETWORK 2 (IRELAND)	6	7

For details, you can consult the JVC Customer Liaison at: 0181-208-7654

With Video Plus+, timer programming is greatly simplified because each TV programme has a corresponding code number which your recorder is able to recognise.

NOTE:

"Guide Program (GUIDE PROG) number" refers to the assigned TV station numbers, according to broadcast area, for Video Plus+ timer recording.

IMPORTANT

Perform the following procedure after Auto Set Up on page 8 and/or the channel setting steps on pages 34 – 39, and after the Clock Set procedure on page 42.

After setting the Guide Program numbers, the station names and preset positions may be incorrect if you stored or skipped channels. In this case, re-perform Guide Program number setting.

For Video Plus+ timer recording to work correctly, it is necessary for the Guide Program to be set properly. This should have already been performed during Auto Set Up or Auto Channel Set, but the following steps will help you check the settings and make corrections if necessary.

Guide Program Number Set

1 MAKE LIST OF STORED STATION NAMES AND PRESET POSITIONS

(Ex.)

Preset position	Station name
1	BBC1
2	BBC2
3	ITV
4	CH4
5	CH5

2 ACCESS MAIN MENU SCREEN

Press **MENU** twice.

3 ACCESS GUIDE PROG SET SCREEN

Press **PUSH JOG** $\Delta \nabla$ to move the highlight bar (pointer) to "GUIDE PROG SET", then press **OK**. The Guide Prog. Set screen appears.

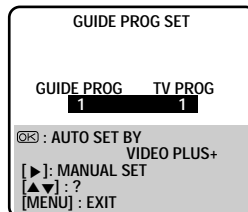
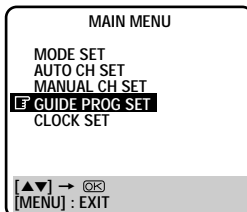

4

ENTER PLUSCODE NUMBER

Press **OK**, and a cursor appears above "GUIDE PROG". Then, using the **NUMBER** keys, input the **PlusCode** number (found in most TV listings) of a program scheduled to be broadcast on each station on the list from step 1, starting at the top. If you enter the wrong number, press **CANCEL** to backspace and input the correct number.

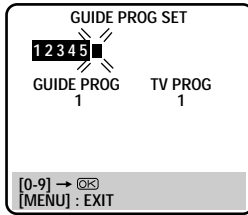

5

CONFIRM PRESET POSITION NUMBER

Press **OK** and the display under "TV PROG" starts to flash.

If the flashing number under "TV PROG" agrees with the preset position . . .
 . . . press **OK**.

If the numbers do not agree . . .

. . . input the preset position using **PUSH JOG** Δ ∇ or the **NUMBER** keys, then press **OK**.

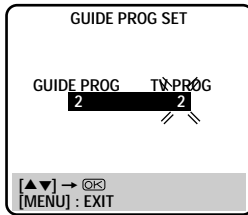

- If you input the PlusCode number of a program that has already aired, "ERROR" appears on screen for a few seconds. Input the correct PlusCode number.
- Repeat steps 4 and 5 as necessary.

6

CLOSE MENU

Press **MENU** and selection is complete.

When Using A Satellite Receiver And/Or Cable System

THE SATELLITE RECEIVER IS SHOWN CONNECTED TO THE "AV2 IN" (SCART) CONNECTOR AND THE CABLE SYSTEM CONNECTED VIA THE AERIAL SOCKET AND TUNED TO, FOR EXAMPLE, PRESET POSITION 6 ON YOUR TV.

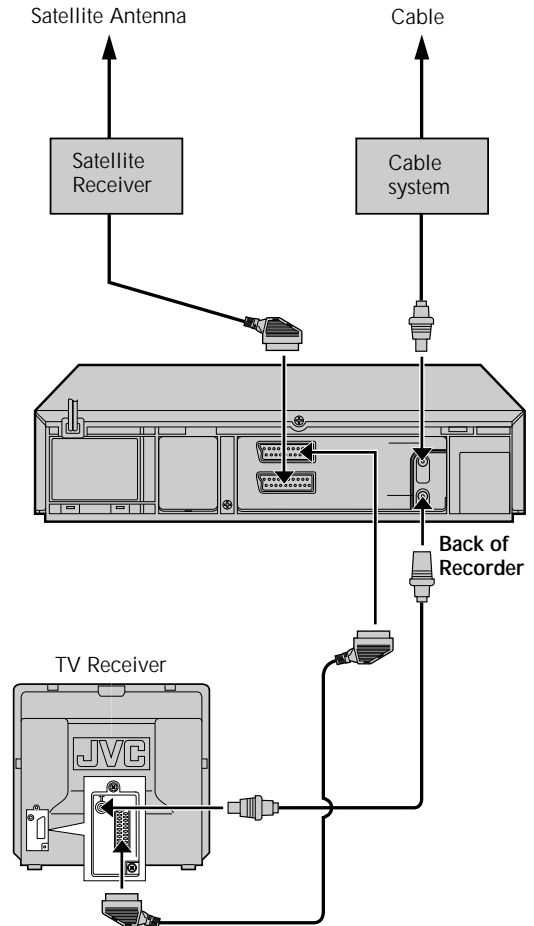

If you already know the Guide Program number for a station . . .

- 1- After step 3, press **PUSH JOG** \triangleright .
 - The GUIDE PROG number starts to flash.
- 2- Enter the Guide Program number using the **NUMBER** keys or **PUSH JOG** Δ ∇ , then press **PUSH JOG** \triangleright .
 - The TV PROG number starts to flash.
- 3- Enter the preset position using the **NUMBER** keys or **PUSH JOG** Δ ∇ , then press **PUSH JOG** \triangleleft .
 - Repeat 2 and 3 as necessary.
- 4- Press **MENU** .

NOTES:

- If you own a satellite receiver, connect it to the AV2 IN connector on the back of the recorder. Then, in step 5 above, set the input mode to "AUX2" by pressing **NUMBER** key "0" or **TV PROG** +/-.
- If you're receiving broadcasts via a cable box through preset "6" (example) on your recorder, set "TV PROG" for "6" in step 5.
- After selecting the programme you wish to record from your cable system or satellite receiver, set the system's timer — if your cable or satellite receiver does not have a timer, leave it switched on.

Basic Playback

Turn on the TV and select the VIDEO channel (or AV mode).

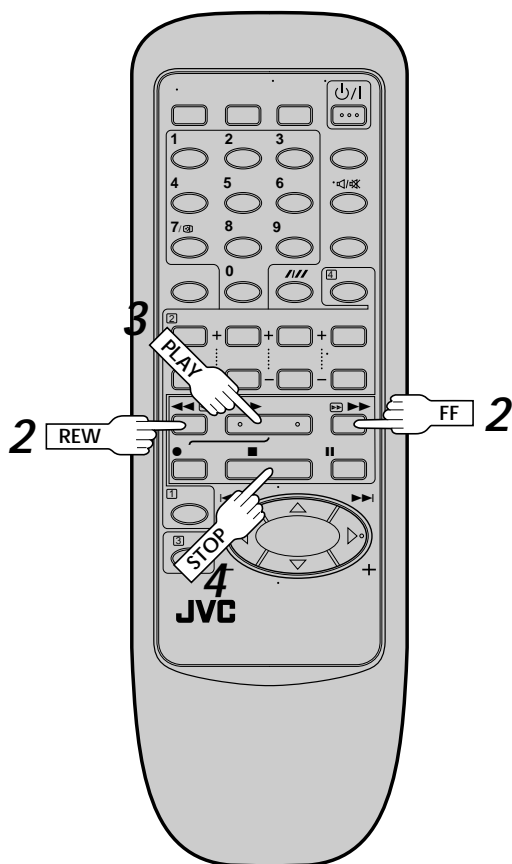
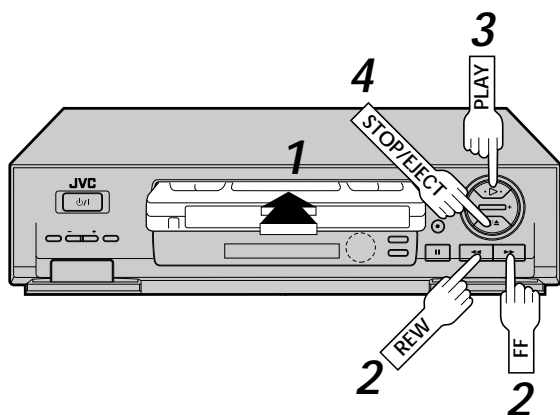

The easiest, most basic operation possible with your video recorder is tape playback. Already-recorded signals on a video tape are read by your video recorder and displayed on your TV just like a TV programme.

1

LOAD A CASSETTE

Make sure the window side is up, the rear label side is facing you and the arrow on the front of the cassette is point toward the recorder. Don't apply too much pressure when inserting.

- The recorder power comes on automatically and the counter is reset to 0:00:00.
- If the record safety tab has been removed, playback begins automatically.

2

FIND PROGRAMME START POINT

If the tape is advanced past the start point, press **REW**. To go forward, press **FF**.

3

START PLAYBACK

Press **PLAY**. "BEST" appears blinking in the recorder's display panel during automatic tracking (see pg. 20).

- Playback picture quality of LP recordings will not be as high as SP recordings.

4

STOP PLAYBACK

Press **STOP** on the remote or **STOP/EJECT** on the recorder's front panel. Then press **STOP/EJECT** to remove the cassette.

Usable cassettes

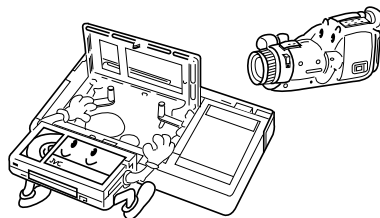

- Compact VHS camcorder recordings can be played on this video recorder. Simply place the recorded cassette into a VHS Cassette Adapter and it can be used just like any full-sized VHS cassette.
- This video recorder can record on regular VHS and Super VHS cassettes. However, it will record and play back regular VHS signals only. It is not possible to play back a recorded Super VHS tape.

Playback Features

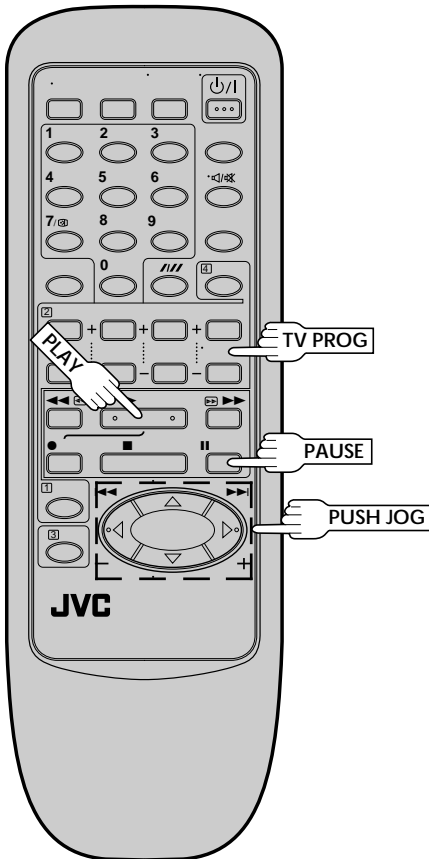
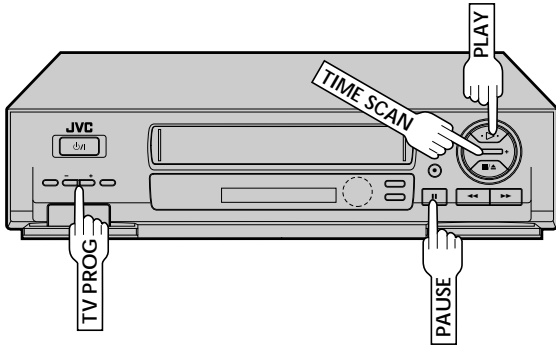

Take advantage of special functions possible with the recorder's controls or the remote control.

Still Picture/Frame-By-Frame Playback

1

PAUSE DURING PLAYBACK

Press **PAUSE**. If there is vertical jitter, use the **TV PROG** buttons to correct the picture.

- During still picture, the sound from the previous 3 seconds (approx.) will be played back repeatedly (provided there was at least 6 seconds of normal playback prior to engaging the still picture mode).
- The "TIME SCAN AUDIO" must be set to "ON", or the sound will not be heard (see pg. 17).

2

ACTIVATE FRAME-BY-FRAME PLAYBACK

Press **PAUSE** again.

OR

Press **PUSH JOG** ◀ or ▶ on the remote control or **TIME SCAN** + or - on the recorder.

To resume normal playback, press **PLAY**.

NOTE:

In the still, or frame by frame playback mode, the picture may be distorted, and there may be a loss of colour.

Slow Motion

1

ACTIVATE SLOW-MOTION PLAYBACK

Press **PUSH JOG** ◀ or **TIME SCAN** - during playback to decrease speed in the forward direction. To play in reverse slow-motion (and in reverse play mode), continue to press **PUSH JOG** ◀ or **TIME SCAN** - after selecting all the forward direction slow-motion modes.

OR

During still picture, press and hold **PAUSE** for 2 seconds, then release. Press and release again to return to still picture.

OR

During still picture, press and hold **PUSH JOG** ◀ or ▶ on the remote control or **TIME SCAN** + or - on the recorder. Release to return to still picture.

To resume normal playback, press **PLAY**.

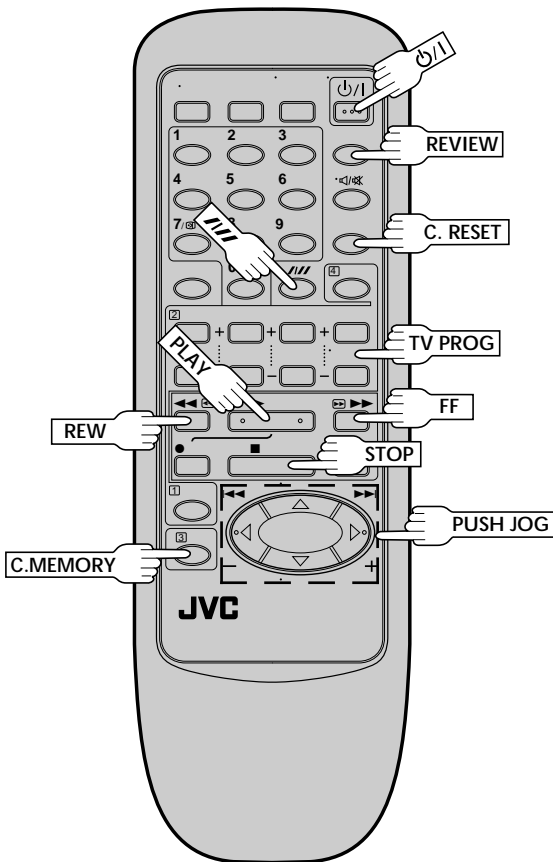
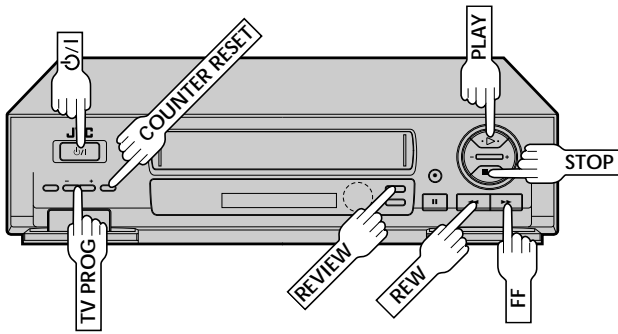

Next Function Memory

You can set your recorder's power to go off automatically after the tape is fully rewound. Before starting, make sure the recorder is in the Stop mode.

For Automatic Power Off After Tape Rewind . . .
 . . . press **REW**, then press **POWER** within 2 seconds.

NOTE:

If you want the power to be turned off automatically when the counter reads "0:00:00" (instead of at the beginning of the tape), press **C.MEMORY** so that the "M" mark appears before pressing **REW**.

Manual Tracking

Your video recorder is equipped with automatic tracking control. During playback, you can override this and adjust the tracking manually by pressing the **TV PROG** buttons.

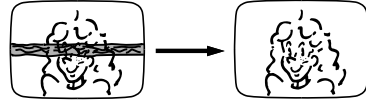

1 OVERRIDE AUTOMATIC TRACKING

Press **///** on the remote to engage manual tracking.

2 ADJUST TRACKING MANUALLY

Press **TV PROG +** or **-** to adjust tracking.

3 RETURN TO AUTOMATIC TRACKING

Press **///** on the remote to re-engage automatic tracking.

NOTE:

When a new tape is inserted, the recorder enters the automatic tracking mode automatically.

Instant ReView

Simply by pressing a single button, the recorder power comes on, rewinds, and begins playback of the last timer-recorded programme. If you have several programmes recorded, you can easily access any of them.

NOTE:

Before starting, make sure that the recorder is off and that the Timer mode is disengaged.

1 ACTIVATE INSTANT REVIEW

Press **REVIEW**. The recorder power comes on and the recorder searches for the index code indicating the start of the last timer-recorded programme. Once it's found, playback begins automatically.

The front display panel tells you how many programmes have been recorded. If you have, for example, 3 programmes, "REVIEW" and "3" appear and blink. To watch the first of the 3 programmes, press **REVIEW** three times. The recorder searches and begins playback automatically. You can access a programme as far as 9 index codes away from the current tape position.

NOTE:

Instant ReView is not possible while the recorder is in the Timer mode.

Index Search

Your recorder automatically marks index codes at the beginning of each recording. This function gives you quick access to any one of 9 index codes in either direction.



NOTE:

Before starting, make sure the recorder is in the Stop mode.

1

ACTIVATE INDEX SEARCH

Press **PUSH JOG** < or > (◀◀ or ▶▶). "◀◀ 1" or "▶▶ 1" is displayed on screen and search begins in the corresponding direction.

- To access index codes 2 through 9, press **PUSH JOG** < or > repeatedly until the correct index number is displayed.

Ex.: To locate the beginning of B from the current position, press **PUSH JOG** < twice.
To locate the beginning of D from the current position, press **PUSH JOG** > once.

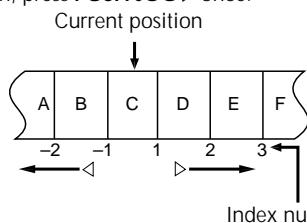

- When the specified index code is located, playback begins automatically.

Counter Memory

Returns to the counter reading of "0:00:00" to conveniently find a specific place on the tape automatically.

1

SET COUNTER MEMORY

Press **C. (COUNTER) RESET** during playback at a point you wish to locate later. The counter reads "0:00:00". Then press **C.MEMORY**, and "M" appears in front of the counter digits.

2

ACTIVATE COUNTER MEMORY

When you wish to return to the designated point, press **STOP** and then **REW** or **FF**.

- The tape rewinds or fast-forwards and stops at about 0:00:00 automatically.
- To cancel Counter Memory, press **C.MEMORY** again.

Repeat Playback

Your video recorder can automatically play back the whole tape 20 times repeatedly.

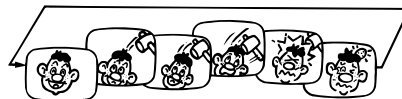

1

START PLAYBACK

Press **PLAY**.

2

ACTIVATE REPEAT PLAYBACK

Press **PLAY** and hold for over 5 seconds, then release.

- The Play indicator (▷) on the display panel blinks slowly.
- The tape plays 20 times automatically, and then stops.

3

STOP PLAYBACK

Press **STOP** at any time to stop playback.

NOTE:

Pressing **PLAY**, **REW**, **FF** or **PAUSE** also stops Repeat Playback.

NTSC Playback

Your video recorder is equipped with NTSC circuitry that can play back NTSC tapes.

1

LOAD A CASSETTE

Insert a cassette recorded in NTSC.

2

START PLAYBACK

Press **PLAY**.

- "NTSC" appears on the screen for about 5 seconds.
- Some TVs shrink the picture vertically and place black bars at the top and bottom of the screen. This is not a malfunction on the part of either the video recorder or the TV.
- The picture may roll up and down. This can be corrected using the V-HOLD control found on some TVs. (This cannot be corrected if the TV does not have a V-HOLD control.)
- The counter and tape remaining time readings will be incorrect.
- During search, still, or frame-by-frame playback, the picture will be distorted, and there may be a loss of colour.
- Depending on the type of TV, the top and bottom portions of superimposed displays may be cut off during NTSC playback.

TimeScan

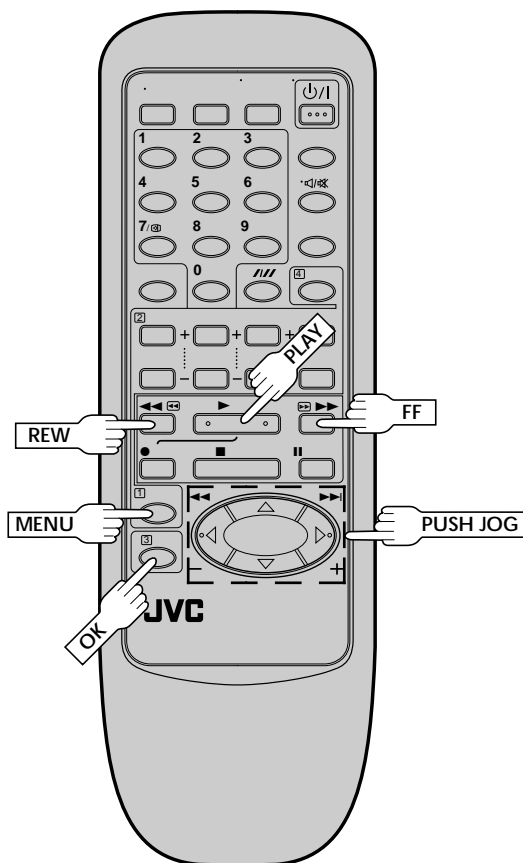
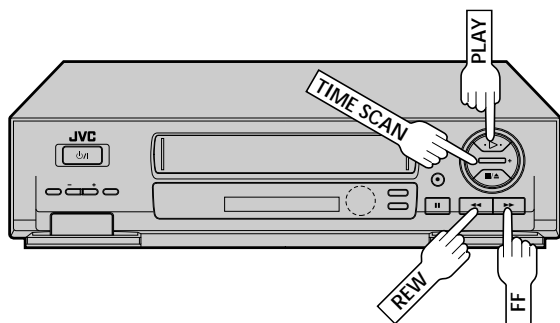

Your recorder is equipped with the TimeScan function. TimeScan allows noise free pictures to be displayed on your TV screen in the forward and reverse search modes. Audio will be played back at normal speed during any of the TimeScan modes (see pg. 17). TimeScan allows you to view a program in search mode while listening to the audio. The default setting for TimeScan audio is ON. (see pg. 17)

NOTES:

- The "TIME SCAN AUDIO" must be set to "ON", or the sound will not be heard in TimeScan mode.
- The audio will not synchronize with the video in TimeScan modes.
- In Pause mode 3 seconds (approx.) of audio will be played back repeatedly. (see pg. 13)
- In TimeScan search modes some of the audio information will not be played so that the audio can keep up with the video.
- TimeScan does not work with NTSC playback.

Audio signal during TimeScan

Playback tape

1	2	3	4	5
---	---	---	---	---

Sound of 1, 3 and 5 is heard.

Sound of 2 and 4 is not heard.

Output audio signal is normal (monaural) sound.

High-Speed Search

ACTIVATE HIGH-SPEED SEARCH

1

During playback or still, press **FF** for forward high-speed search, or **REW** for reverse high-speed search.

To resume normal playback, press **PLAY**.

NOTES:

- For short searches, press and hold **FF** or **REW** for over 2 seconds. When released, normal playback resumes.
- Picture may not appear during search with an LP-recorded tape.
- In the search, the picture may be distorted, and there may be a loss of colour.

Variable-Speed Search

ACTIVATE VARIABLE-SPEED SEARCH

1

During playback, press **PUSH JOG** < or > on the remote control or **TIME SCAN** + or - on the recorder.

- The more times you press, the faster the playback picture moves.
- To decrease speed, press the button for the opposite direction.

(Refer to the chart on pg. 17 for playback speeds.)

To resume normal playback, press **PLAY**.

TimeScan

Names of special-effects playback	Reverse				Forward			
	Search	Play	Slow-Motion	*Still	Slow-Motion	Play	Search	
Speed SP	-9x -7x -5x -3x	-1x	-1/6x -1/18x	0	1/18x 1/6x	1x	2x 3x 5x 7x 9x	
Speed LP	-7x -3x		-1/6x -1/18x	0	1/18x 1/6x	1x	2x 5x 9x	
Audio output	Audio is output.		Audio is not output.	Audio is output.	Audio is not output.	Audio is output.		

* Still mode cannot be engaged using the remote control's **PUSH JOG** or the recorder's **TIME SCAN** button.

- The speed is shown during TimeScan in the upper right corner of the TV screen for approx. 5 seconds. (The display may be distorted.)
- To resume normal playback, press **PLAY**.
- Picture and audio may become distorted when the recording speed changes. When this happens, resume normal playback once, and then try using TimeScan again.
- The picture may be noisy or there may be a loss of colour when you change the playback speed. (More noise will appear with LP recordings.)
- Noise may appear or the upper part of the picture may be distorted during still, frame-by-frame playback, 2x search of LP recordings, or depending on the tape being used.
- Picture may appear distorted in comparison to normal playback.
- In TimeScan mode there will be a time lag between the video and the audio and noise may appear in the audio signal.
- TimeScan sound quality will differ in comparison to normal playback.
- When the playback direction is reversed, it takes approximately 6 seconds until sound is heard.

If you don't want to hear TimeScan audio, set the "TIME SCAN AUDIO" to OFF. (See below)

TimeScan Audio

The audio output can be set ON/OFF during TimeScan. Select ON/OFF as required.

- 1 Press **MENU** twice to access the Main Menu screen.
- 2 Move the highlight bar (pointer) to "MODE SET" by pressing **PUSH JOG** $\Delta \nabla$, then press **OK**.
- 3 Move the highlight bar (pointer) to "TIME SCAN AUDIO" by pressing **PUSH JOG** $\Delta \nabla$, then press **PUSH JOG** \triangleright to select "ON" or "OFF".
- 4 Press **MENU** to return to the normal screen.

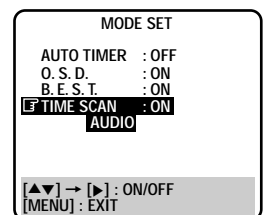

Basic Recording

Turn on the TV and select the VIDEO channel (or AV mode).

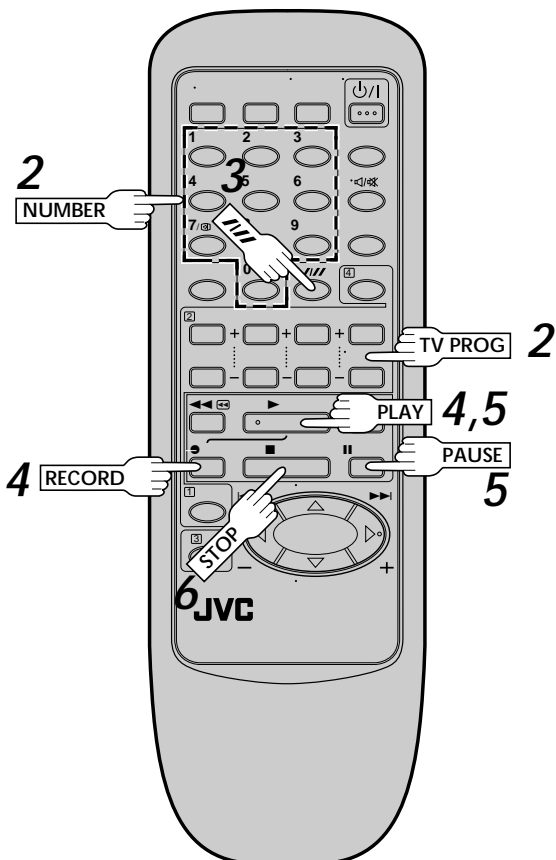
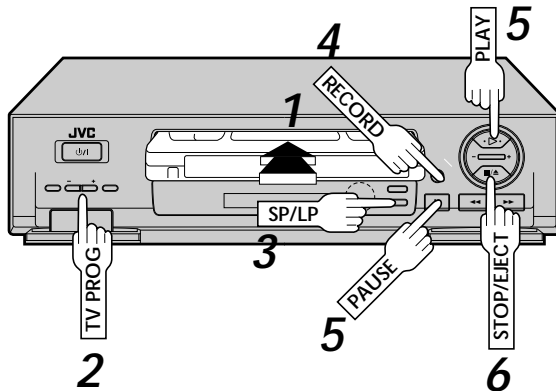

TV signals being received by the recorder's built-in tuner can be recorded onto a video tape. You can "capture" a TV programme using your video recorder.

1 LOAD A CASSETTE

Insert a cassette with the record safety tab intact.

- The counter is reset to 0:00:00 and the recorder power comes on automatically.

2 CHOOSE A PROGRAMME

Press **TV PROG +/-** or the **NUMBER** keys to select the preset you wish to record.

3 SET TAPE SPEED

Press **SP/LP (//)**. Check the SP/LP indicator on the recorder display panel to confirm the selected tape speed.

- Picture quality of LP recordings will not be as high as SP recordings.

4 START RECORDING

Press and hold **RECORD** and press **PLAY** on the remote control, or press **RECORD** on the recorder.

B.E.S.T. takes place at the beginning of both the first SP and the first LP recording after inserting the cassette (see pg. 20).

5 PAUSE/RESUME RECORDING

Press **PAUSE**. Press **PLAY** to resume recording.

6 STOP RECORDING

Press **STOP** on the remote control or **STOP/EJECT** on the recorder. Then press **STOP/EJECT** to remove the cassette.

Accidental erasure prevention

- To prevent accidental recording on a recorded cassette, remove its safety tab. To record on it later, cover the hole with adhesive tape.

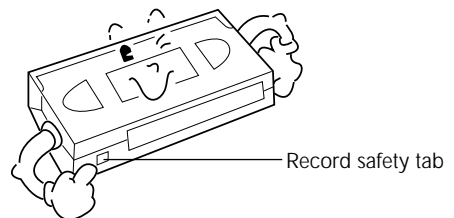

Recording Features

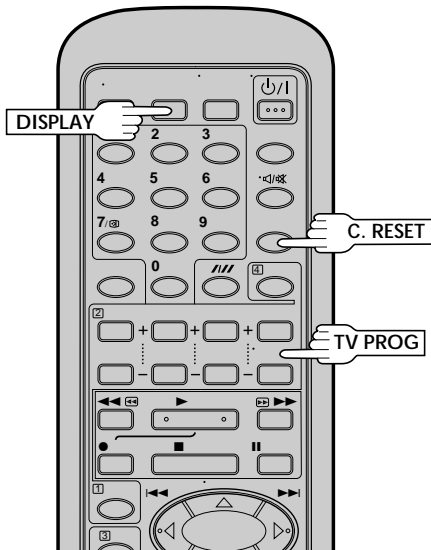
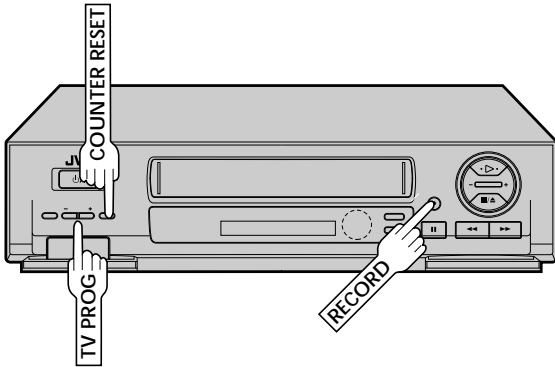

Record One Programme While Watching Another

1

SELECT PRESET TO WATCH

Once recording is in progress, all you need to do is to set the preset controls on the TV for the station you wish to view.

- The programme selected with the TV's preset controls appears on the TV screen while the one selected with the recorder's **TV PROG** buttons is recorded on the tape.

Elapsed Recording Time Indication

You can check the exact time of a recording.

1

SET COUNTER DISPLAY

Press **DISPLAY** until a counter reading appears on the display panel.

2

RESET COUNTER

Press **C. (COUNTER) RESET** before starting recording or playback.

- The counter is reset to "0:00:00" and shows the exact elapsed time as the tape runs.

Instant Timer Recording (ITR)

This easy method lets you record for from 30 minutes to 6 hours (selectable in 30-min. increments), and shuts the recorder off after recording is finished.

1

START RECORDING

Press **RECORD** on the recorder.

2

ENGAGE ITR MODE

Press **RECORD** again. "O" blinks and 0:30 appears on the front display panel.

3

SET RECORDING DURATION

If you want to record for more than 30 minutes, press **RECORD** to extend the time. Each press extends recording time by 30 minutes.

NOTE:

You can only perform ITR using the **RECORD** button on the recorder's front panel.

Tape Remaining Time

1

DISPLAY REMAINING TIME

Press **DISPLAY** until the time remaining on the tape appears.

- By pressing the **DISPLAY** button, you can change the display to show the counter reading, preset position, clock time* or tape remaining time.

* Preset position is not displayed during playback.

NOTE:

Depending on the type of tape used, there may be times when the tape remaining time reading may not appear right away, or is not correct. "- : -" may sometimes appear, or the display may blink on occasion.

B.E.S.T. Picture System

Turn on the TV and select the VIDEO channel (or AV mode).

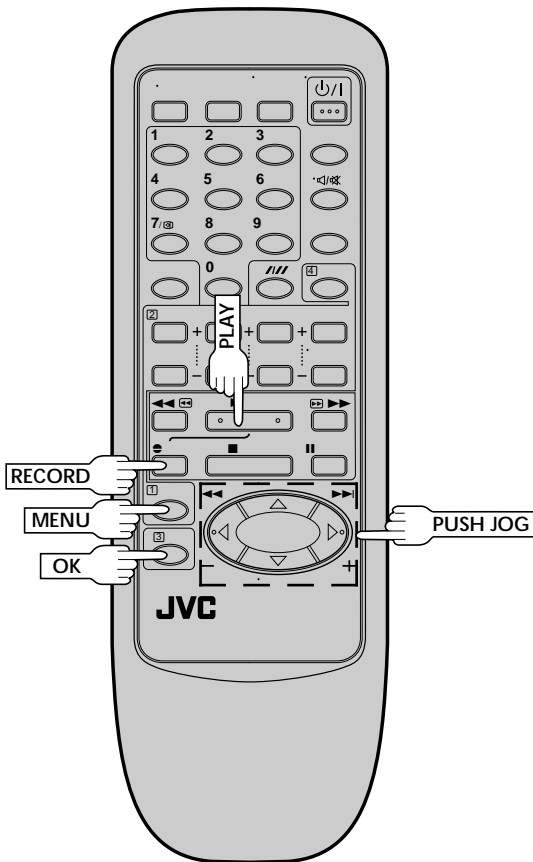
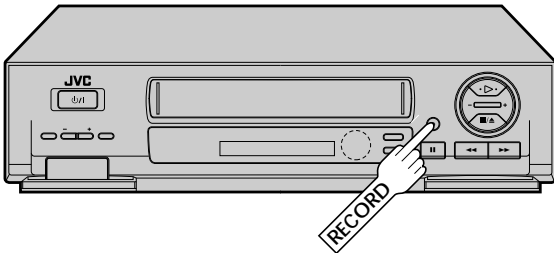

Display Panel Indication



As the tape check progresses, the "--" marks on the display panel increase upward. Once the "BEST" indicator starts blinking, the check is complete.

The B.E.S.T. (Biconditional Equalised Signal Tracking) system checks the condition of the tape in use during recording and playback, and compensates to provide the highest-possible recording and playback pictures. The default setting for both recording and playback is "ON".

Recording

1 LOAD A CASSETTE

Insert a cassette with the record safety tab intact.

- The recorder power comes on automatically.

2 ACCESS MAIN MENU SCREEN

Press **MENU** twice.

3 ACCESS MODE SET SCREEN

Move the highlight bar (pointer) to "MODE SET" by pressing **PUSH JOG** Δ / ∇ , then press **OK**.

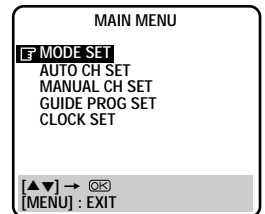

4 CONFIRM B.E.S.T. STATUS

The default setting is "ON". If this is the case, go to step 5. If not, press **PUSH JOG** ∇ to move the highlight bar (pointer) to "B.E.S.T.", then press **PUSH JOG** \triangleright to set to "ON".

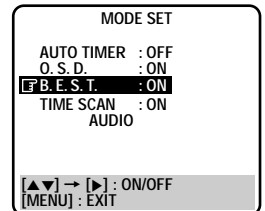

5 RETURN TO NORMAL SCREEN

Press **MENU**.

6 START RECORDING

Press and hold **RECORD** and press **PLAY** on the remote, or **RECORD** on the recorder.

- The recorder spends approximately 7 seconds assessing the condition of the tape, then begins recording.
- When the "BEST" indicator begins blinking, that means adjustment is complete.
- Pressing the recorder's **RECORD** button while "BEST" is displayed does not start Instant Timer Recording (see pg. 19).

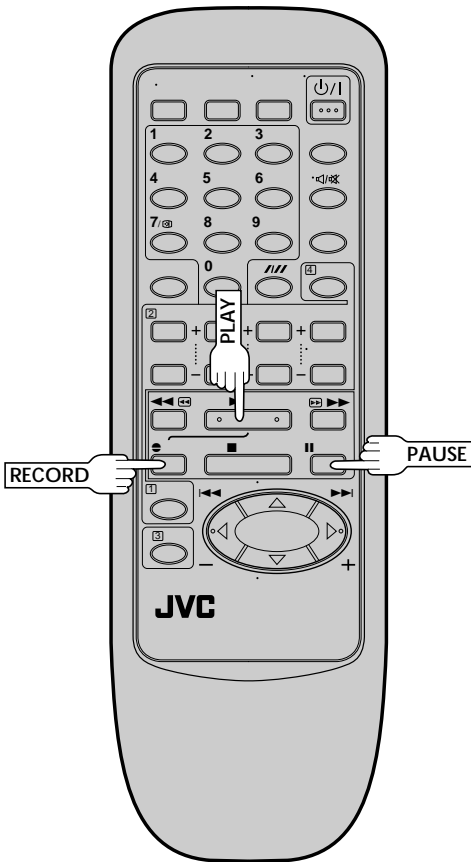
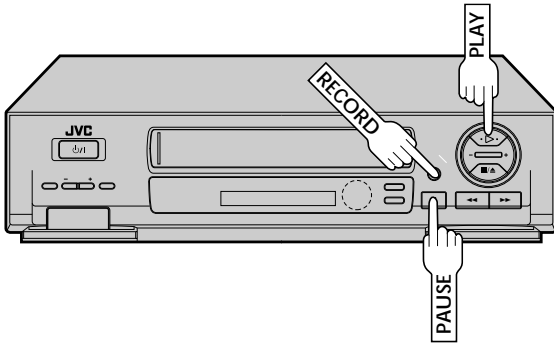

NOTES:

- The B.E.S.T. system works for both SP and LP modes only after a tape has been inserted and the Record mode is first initiated. It does not work during recording.
- In the case of timer recording, the B.E.S.T. system works before recording is initiated.
- Once the cassette is ejected, the B.E.S.T. data is cancelled. The next time the cassette is used for recording, B.E.S.T. is re-performed.

ATTENTION:

Since the B.E.S.T. system works before recording actually starts, there is a delay of approximately 7 seconds after **RECORD** and **PLAY** on the remote are pressed, or **RECORD** on the recorder is pressed. To make sure you record the desired scene or programme in its entirety, first perform the following steps:

- 1) Press and hold **PAUSE** and **RECORD** to engage the RECORD PAUSE mode.
 - The recorder then automatically checks the condition of the tape and, after approximately 7 seconds, re-enters RECORD PAUSE.
- 2) Press **PLAY** to start recording.
 - If you want to bypass the B.E.S.T. system and begin recording immediately, set "B.E.S.T." to "OFF" in step 4 on page 20.

Playback

The recorder assesses the quality of the tape once you initiate playback. When watching a tape recorded with "B.E.S.T." set to "ON", it is recommended that you leave B.E.S.T. on during playback as well.

START PLAYBACK

1

Press **PLAY**.



- The recorder adjusts the playback picture quality based on the quality of the tape in use.
- B.E.S.T. is active during Auto Tracking. "BEST" appears blinking on the recorder's display panel.

NOTES:

- When watching a rental tape or one recorded on another video recorder, or when using this recorder as the player for editing, set B.E.S.T. to your preference by performing steps 2 through 5 on page 20.
- "BEST" only appears at the beginning of automatic tracking. Even though it doesn't appear after that, the B.E.S.T. function is operative.

Video Plus+ Timer Recording

Before performing Video Plus+ Timer Recording:

- Be sure to read "Video Plus+ Setup" (pg. 10).
- Insert a cassette with the safety tab in place. The recorder will come on automatically.
- Turn on the TV and select the VIDEO channel (or AV mode).

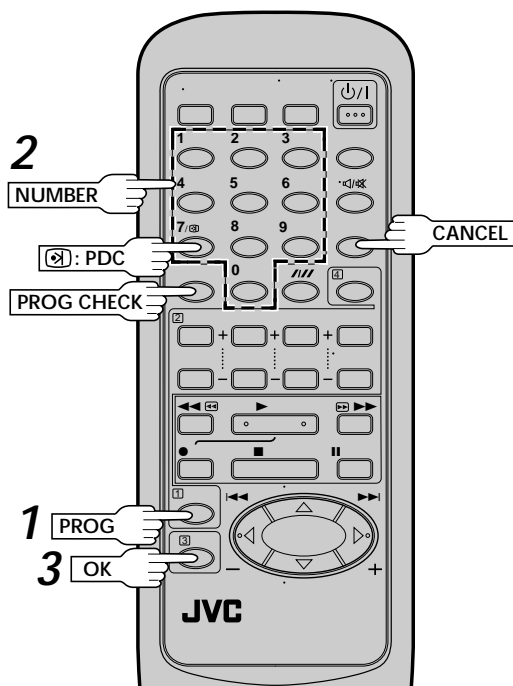

PDC Recording

Now available from some TV stations, PDC (Programme Delivery Control) is a service designed to assure safe, accurate timer recording. With this system, special code signals are transmitted together with the audio/video signals. These code signals control your video recorder and have precedence over advertised times you preset in the timer. This means that your recorder will start and stop recording when the preset TV programmes actually start and end — even if the broadcast time of a preset TV programme is changed.

NOTES:

- PDC Recording is also possible when a satellite receiver or a cable system is connected to AV2 IN on your recorder.
- PDC recording is also possible via the AV1 IN/OUT connector.

ACCESS TIMER PROGRAMMING SCREEN

Press **PROG**

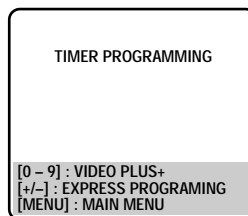

The front display panel looks like this:



ENTER PLUSCODE NUMBER

Press the **NUMBER** keys to enter the PlusCode number of a programme you wish to record.



- If you make a mistake, press **CANCEL** to backspace and then input the correct number.

The PlusCode number you enter appears on the front display panel:



The display panel can show only a 4-digit number.

ACCESS VIDEO PLUS+ PROGRAM SCREEN

Press **OK**, and the Video Plus+ Program screen appears (if you're just starting out, "P1" appears).

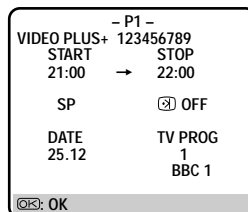

The display panel shows the programme start time. Pressing **PROG CHECK** changes the display to the programme stop time, then the date and preset position.



IMPORTANT

Be sure to confirm the setting of PDC recording.

- If " ON " is displayed on the screen or " " is lit on the display panel, PDC is set to ON.
 - If " OFF " is displayed on the screen or " " is not lit on the display panel, PDC is set to OFF.
- To change the setting, press : **PDC (NUMBER key "7")**,
 "PDC Recording" in the left column.

- Make sure the preset position number you wish to record is displayed; if not, see "Video Plus+ Setup" on page 10 and set the Guide Program number for that PlusCode number correctly.
- If the number you entered is invalid, "ERROR" appears on the screen and "Err" appears on the display panel. Press **CANCEL** to backspace and input a valid PlusCode number.
- If "ERROR=GUIDE PROG" appears on the screen, see "ATTENTION – Regarding Guide Program Number Set" on page 23.

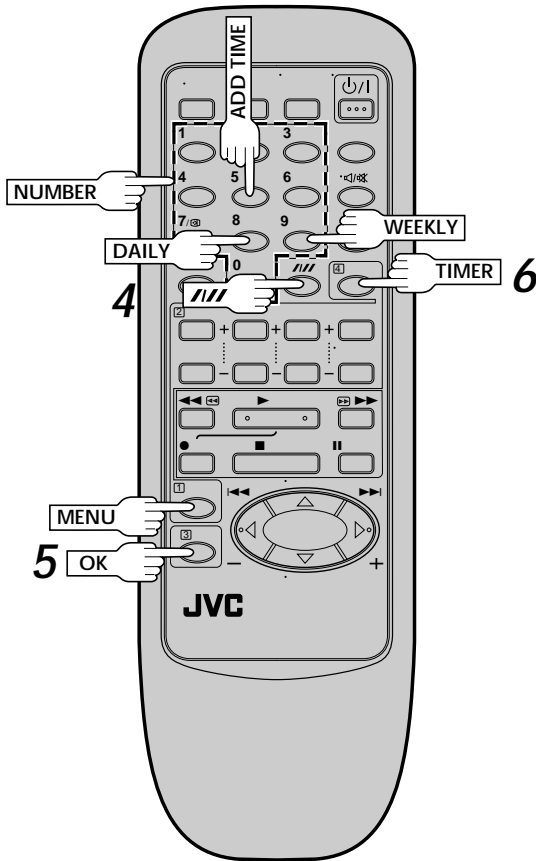
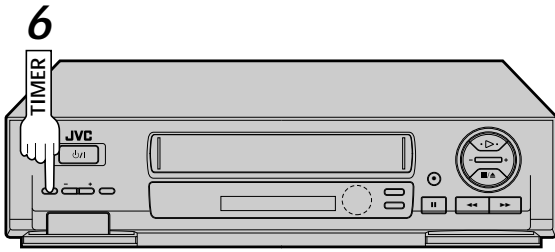

Satellite Receiver Users

To timer-record a satellite broadcast using Video Plus+, perform steps 1 – 6 and, before the selected programme begins, select the appropriate channel on the satellite receiver. Then set the receiver's timer. If your satellite receiver doesn't have a timer, leave the unit's power switched on.

4 SET TAPE SPEED

Press **SP/LP** () to set the tape speed.

5 RETURN TO NORMAL SCREEN

Press **OK**.

- Repeat steps 1 – 5 for each additional programme.

6 ENGAGE RECORDER'S TIMER MODE

Press **TIMER**. The recorder turns off automatically.

NOTE:

To Delay The Stop Time . . .

. . . press **ADD TIME** after pressing **OK** in step 3. Each time you press, the Stop time is delayed by 5 minutes (meaning that 5 minutes of recording time is added). You can easily compensate for anticipated programme schedule delays this way.

To Timer-Record Weekly Or Daily Serials . . .

. . . after pressing **OK** in step 3, press **WEEKLY** (**NUMBER** key "9") for weekly serials or **DAILY** (**NUMBER** key "8") for daily serials (Monday – Friday). Either "WEEKLY" or "DAILY" appears on the screen. Pressing the button again makes the corresponding indication disappear.

You can programme this recorder to timer-record as many as 8 programmes. If you try to programme the recorder to record a ninth, "PROGRAM FULL" appears on screen and "FULL" appears on the front display panel. To record the extra programme, you must first cancel any unnecessary programmes (pg. 26).

ATTENTION

Regarding Guide Program Number Set

"ERROR=GUIDE PROG" appears after performing step 3 on the previous page if the Guide Program number for the PlusCode number you entered has not been set.

- If the recorder is in the stop or rewind or fast-forward mode, the following screen will appear with "--" under "TV PROG" flashing.
- Press the **NUMBER** keys or **PUSH JOG** to input the preset position number your recorder receives that station on, then press **OK**.

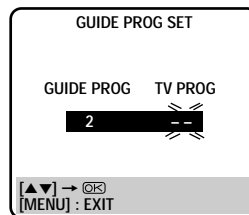

(Ex.) To timer-record a BBC2 programme with Video Plus+
* If your recorder receives BBC2 on the preset position 2, press **OK** after entering "2".

- Press **MENU**, then try again from step 1.
- If the recorder is in a mode other than the above mentioned modes, press **MENU** first and input the correct Guide Program number for that PlusCode number (pg. 10, "Video Plus+ Setup"), then try again from step 1.

Regular Timer Programming

Remember, the clock must be set before you can programme the timer (pg. 42).

Before performing the following steps:

- Insert a cassette with the safety tab in place. The recorder will come on automatically.
- Turn on the TV and select the VIDEO channel (or AV mode).

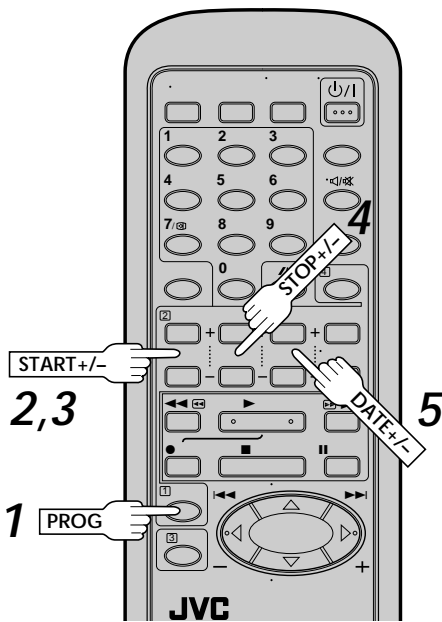

PDC Recording

Now available from some TV stations, PDC (Programme Delivery Control) is a service designed to assure safe, accurate timer recording. With this system, special code signals are transmitted together with the audio/video signals. These code signals control your video recorder and have precedence over advertised times you preset in the timer. This means that your recorder will start and stop recording when the preset TV programmes actually start and end — even if the broadcast time of a preset TV programme is changed.

NOTES:

- Set the start time (PDC time) exactly as advertised in the TV listing. A different time than advertised will result in no recording.
- PDC Recording is also possible when a satellite receiver or a cable system is connected to AV2 IN on your recorder.
- PDC recording is also possible via the AV1 IN/OUT connector.

If you don't know the PlusCode number for the programme you wish to record, use the following procedure to set your recorder to timer-record the programme.

ACCESS TIMER PROGRAMMING SCREEN

Press **PROG**

ACCESS PROGRAMME SCREEN

Press **START +/-**. (If you're just starting out, "P1" appears.)

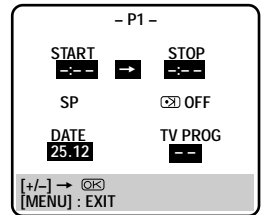

The front display panel looks like this:



ENTER PROGRAMME START TIME

Press **START +/-** to enter the time you want recording to start.

- Press and hold **START +/-** to move in 30-minute increments, or press and release repeatedly to move 1 minute at a time.

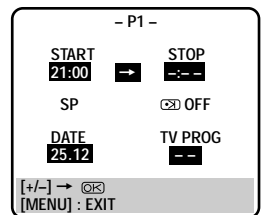

The front display panel looks like this:



ENTER PROGRAMME STOP TIME

Press **STOP +/-** to enter the time you want recording to stop.

ENTER PROGRAMME DATE

Press **DATE +/-**. (The current date appears on screen. The date you enter appears in its place.)

1
2
3
4
5

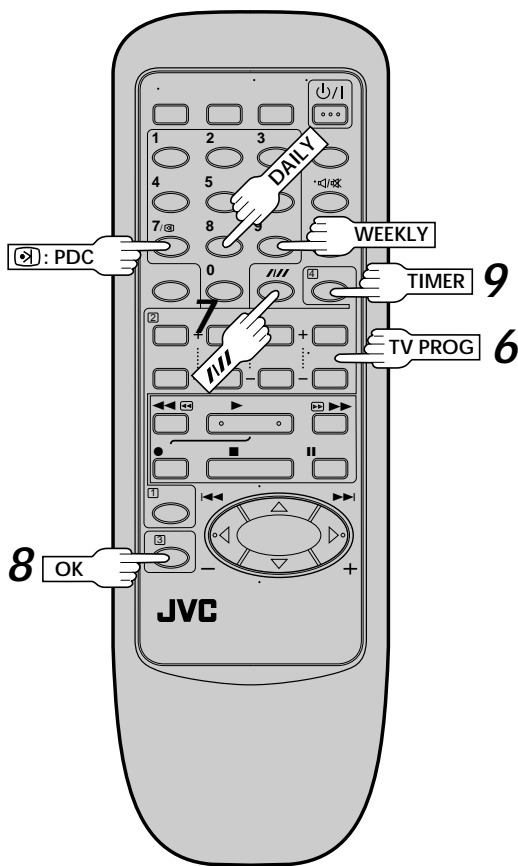
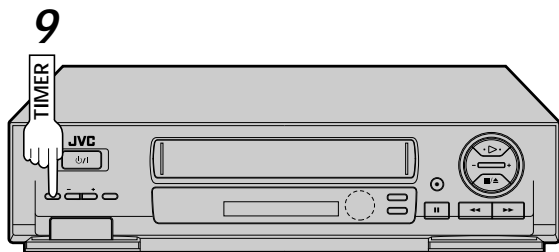

ENTER PRESET POSITION

Press **TV PROG +/-**.

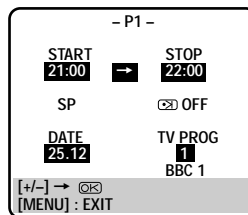

IMPORTANT

Be sure to confirm the setting of PDC recording.

- If " ON" is displayed on the screen or " " is lit on the display panel, PDC is set to ON.
- If " OFF" is displayed on the screen or " " is not lit on the display panel, PDC is set to OFF.

To change the setting, press : **PDC (NUMBER key "7")**.

"PDC Recording" on page 24.

SET TAPE SPEED

Press **SP/LP ()** to set the tape speed.

RETURN TO NORMAL SCREEN

After confirming all information is correct, press **OK** and the normal screen appears.

- Repeat steps 1 – 8 for each additional programme.

ENGAGE RECORDER'S TIMER MODE

Press **TIMER**. The recorder turns off automatically.

To Timer-Record Weekly Or Daily Serials . . .
 . . . anytime during steps 2 through 8, press **WEEKLY (NUMBER key "9")** for weekly serials or **DAILY (NUMBER key "8")** for daily serials (Monday – Friday). Either "WEEKLY" or "DAILY" appears on the screen. Pressing the button again makes the corresponding indication disappear.

NOTES:

- You can programme this recorder to timer-record as many as 8 programmes. If you try to programme the recorder to record a ninth, "PROGRAM FULL" appears on screen and "FULL" appears on the front display panel. To record the extra programme, you must first cancel any unnecessary programmes (pg. 26).
- To timer-record a satellite broadcast through a satellite receiver connected to the AV2 IN connector on the back of the recorder, in step 6 above, set "TV PROG" to "AUX2" by pressing **TV PROG +/-**. Before the selected programme begins, select the appropriate channel on the satellite receiver, then set the receiver's timer. If your satellite receiver doesn't have a timer, leave the unit's power switched on.

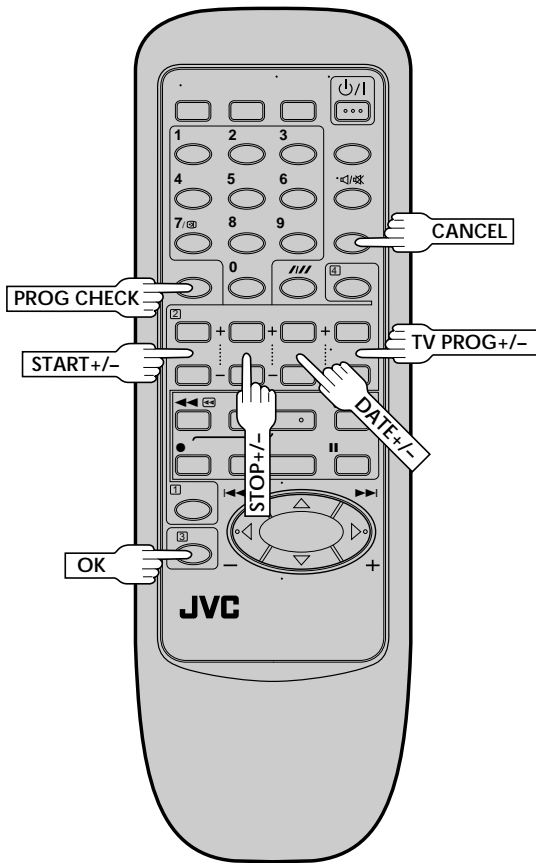

Check And Cancel Programmes

1 ACCESS PROGRAMME DISPLAY AND/OR SCREEN

Press **PROG CHECK**.

- The display panel shows the programme start time. Pressing **OK** changes the display to the programme stop time, then the date and preset position.
- If the recorder is turned on and the TV is set to its VIDEO channel or AV mode, you can check programme information on screen as well.
- Each time you press **PROG CHECK**, the next programme's information appears.

If All Information Is Correct . . .

. . . programming is completed.

If You Wish To Revise Data . . .

. . . with the recorder's power turned on, go to step 2.

If You Wish To Cancel A Program . . .

. . . with the recorder's power turned on, press **CANCEL**.
All information you input is deleted.

2 REVISE PROGRAMME INFORMATION

Input the appropriate data using the **START +/-**, **STOP +/-**, **DATE +/-** and **TV PROG +/-** buttons on the remote control.

Timer Warning

If you have programmed your recorder to timer-record a programme or a series of programmes, a warning appears on screen to tell you that the recording is to start in 5 minutes.

- WARNING -
TIMER RECORDING
TO START SOON
[CANCEL]

NOTES:

- The warning only appears if you're not in the Timer mode at that time.
- If this recorder is being used as the player for tape dubbing, the warning screen is recorded on the tape in the other video recorder.

The warning blinks for the entire 5 minutes leading up to the start of timer recording. To clear the display, press **CANCEL**.

Auto Timer

When the Auto Timer is set to ON the timer is automatically engaged when the recorder power is turned off and automatically disengaged when the recorder is powered back on.

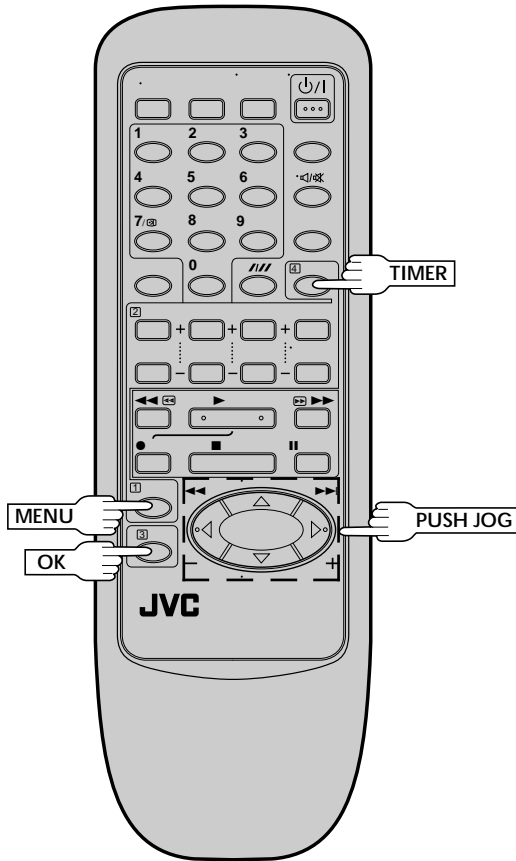

1 ACCESS MAIN MENU SCREEN

Press **MENU** twice.

2 ACCESS MODE SET SCREEN

Press **PUSH JOG** Δ / ∇ to move the highlight bar (pointer) to "MODE SET", then press **OK**.

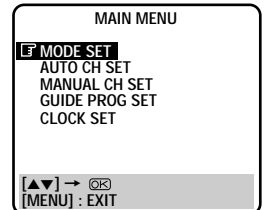

3 SELECT MODE

Press **PUSH JOG** \triangleright to select either "ON" or "OFF".

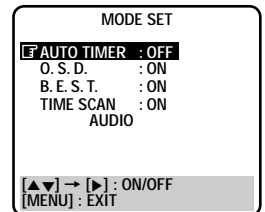

4 RETURN TO NORMAL SCREEN

Press **MENU**.

NOTE:

For safety, when Auto timer is set to "OFF", all other recorder functions are disabled while the Timer mode is engaged. To disengage the timer, press **TIMER**.

Edit To Or From Another Video Recorder

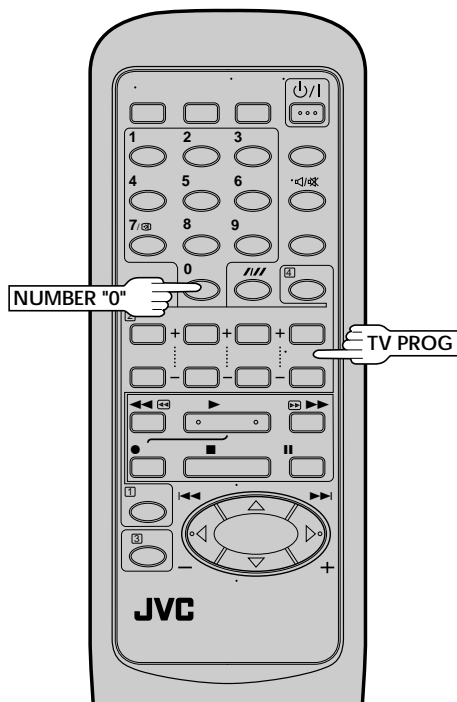

You can use your video recorder as the source player or the recording deck.

1

MAKE CONNECTIONS

Connect the player's 21-pin SCART connector to the recorder's 21-pin SCART connector as illustrated below.

When Using Your Video Recorder As The Source Player . . .

. . . connect its AV1 IN/OUT connector to the recording deck.

When Using Your Video Recorder As The Recording Deck . . .

. . . connect its AV2 IN or AV1 IN/OUT connector to the source player.

2

SET RECORDING DECK'S INPUT MODE

Set to AUX. With this video recorder, press **NUMBER** key "0" and/or **TV PROG** to select depending on the connector being used — "AU-1" for the AV1 IN/OUT connector, or "AU-2" for the AV2 IN connector.

3

START SOURCE PLAYER

Engage its Play mode.

4

START RECORDING DECK

Engage its Record mode.

NOTE:

All necessary cables can be obtained from your dealer.

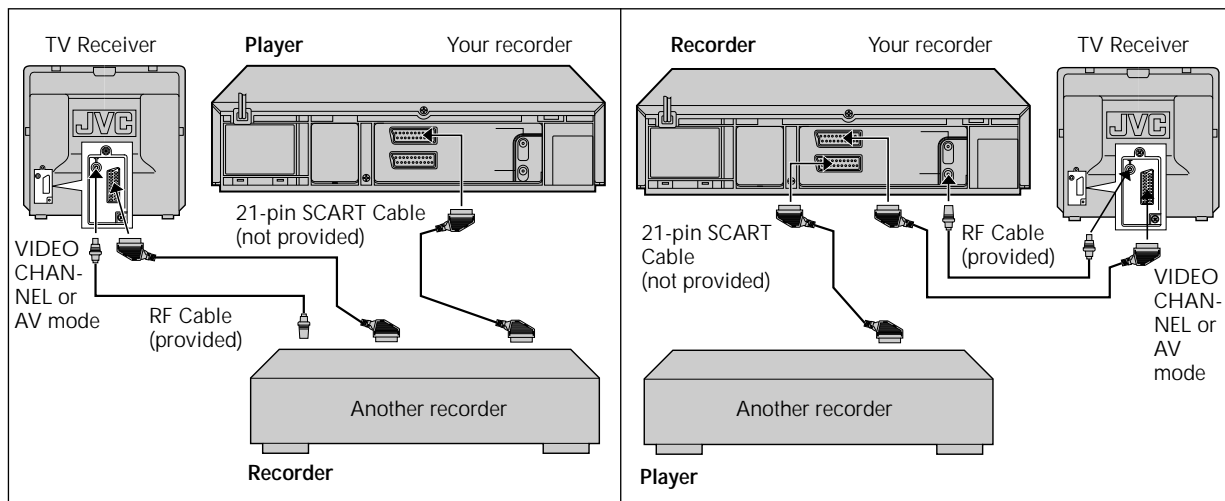

Edit From A Camcorder

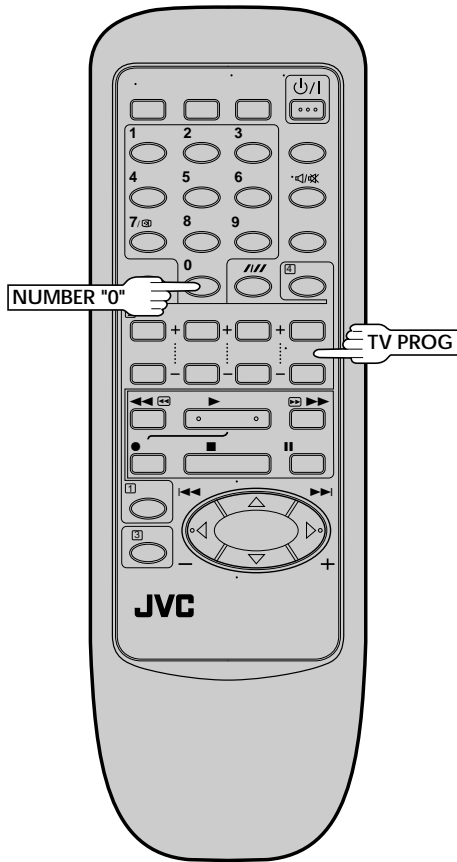

You can use a camcorder as the source player and your video recorder as the recorder.

1

MAKE CONNECTIONS

Connect the camcorder's AUDIO/VIDEO OUT connectors to the recorder's rear panel AV2 IN or AV1 IN/OUT connector via the optional cable adapter.

2

SET RECORDER'S INPUT MODE

Press the **NUMBER** key "0" and/or **TV PROG** to select the appropriate input mode depending on the connector being used; "AU-1" for the AV1 IN/OUT connector, or "AU-2" for the AV2 IN connector.

3

START CAMCORDER

Engage its Play mode.

4

START RECORDER

Engage its Record mode.

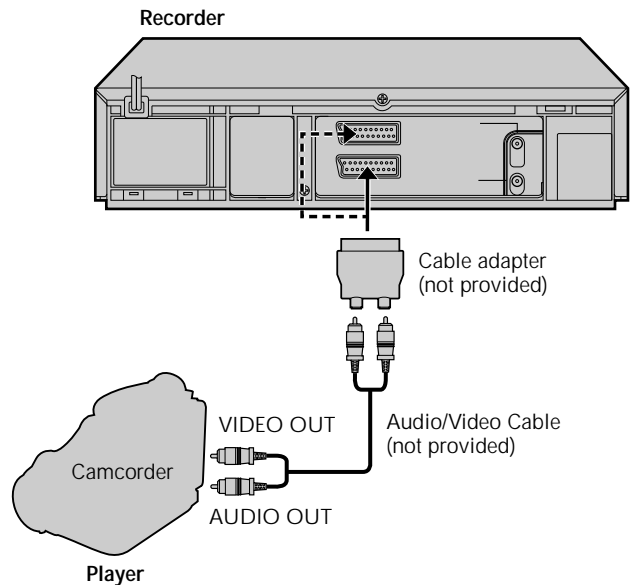

Connection To A Satellite Receiver

The AV2 IN socket on the rear panel of your recorder allows simple connection to a satellite receiver.

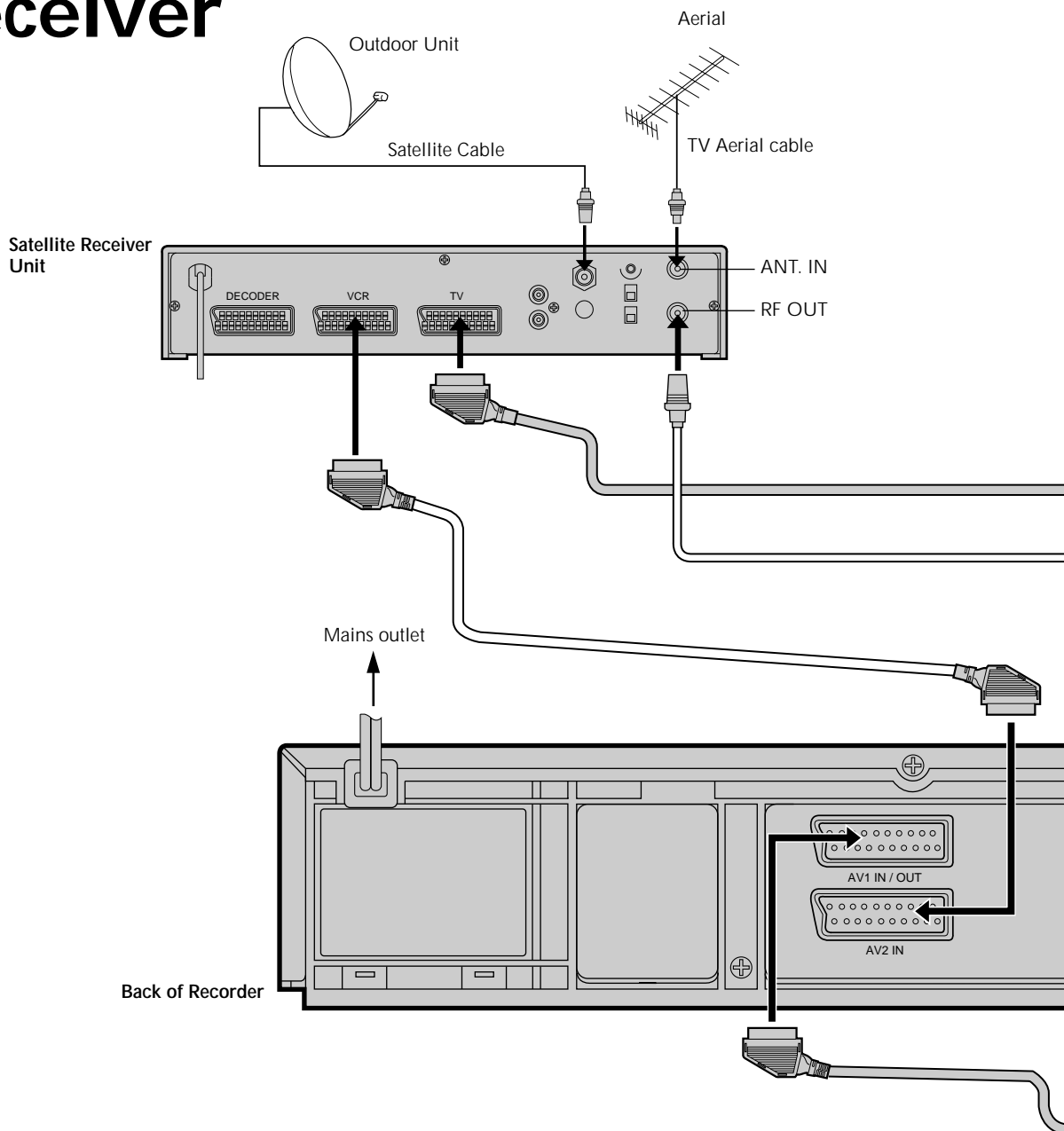

NOTES:

- When connecting your recorder to a TV equipped with 21-pin SCART connectors, follow the illustration above using the cables shown in gray.
- For details, check your satellite receiver's instruction manual.

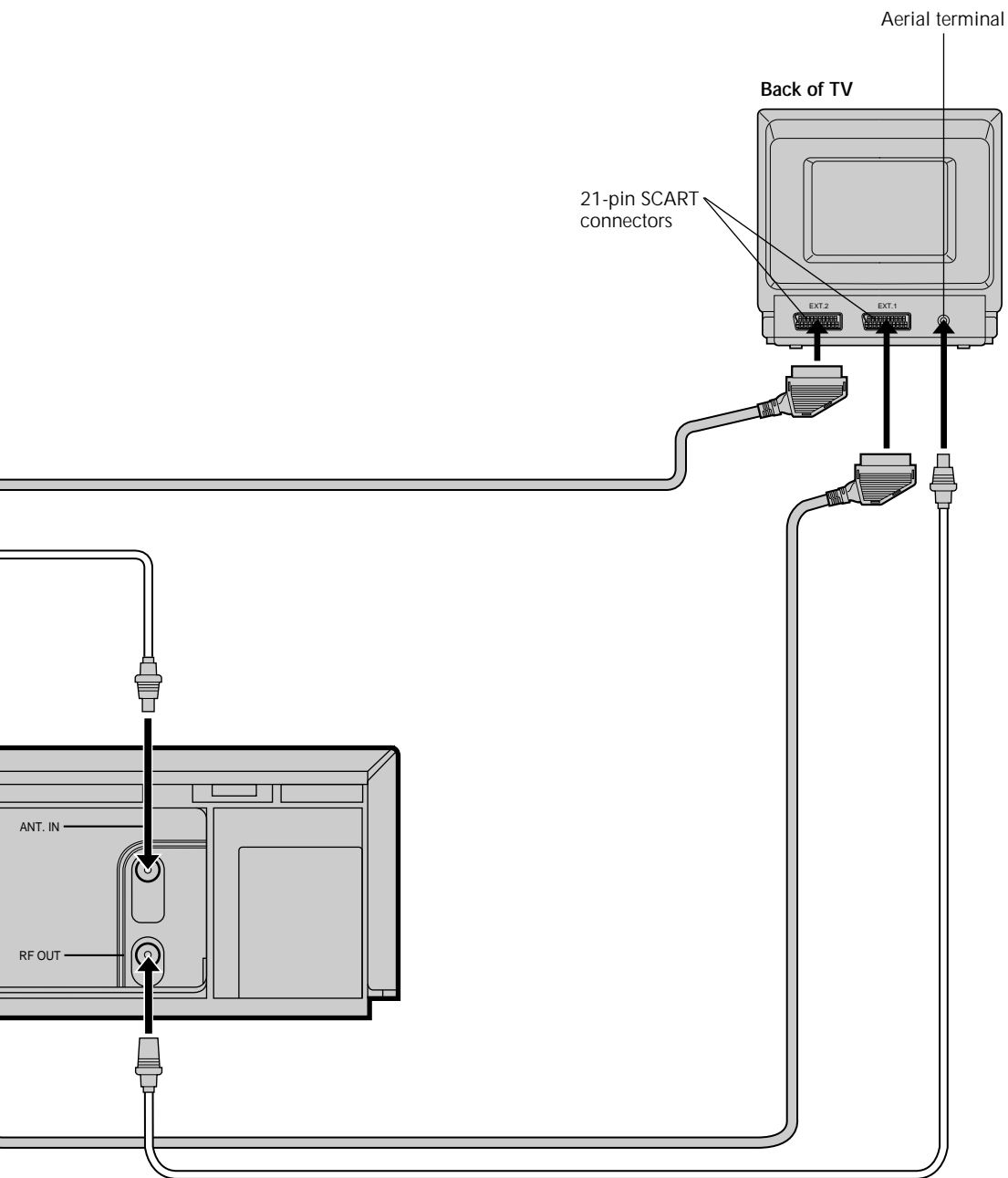

Turn on the TV and select the VIDEO channel (or AV mode).

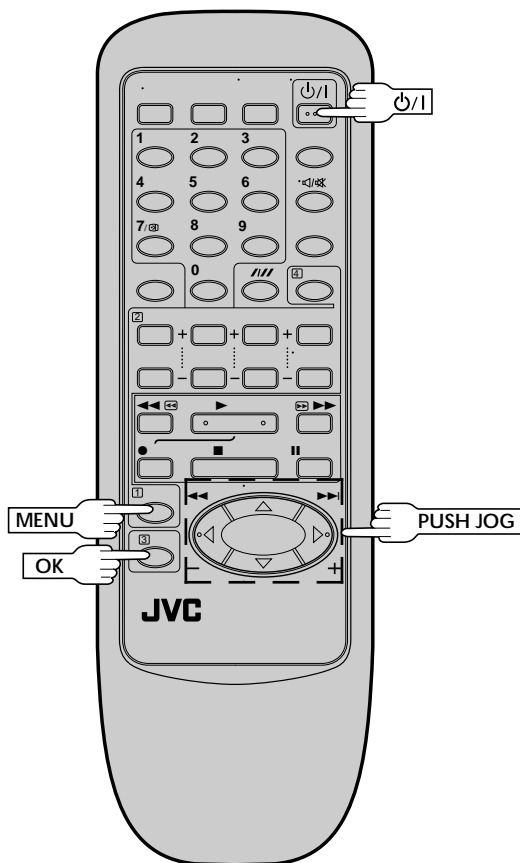

On-Screen Display

You can choose whether or not to have various operational indicators appear on screen, by setting this function ON or OFF.

1 TURN ON THE RECORDER

Press **⏻/I**.

2 ACCESS MAIN MENU SCREEN

Press **MENU** twice.

3 ACCESS MODE SET SCREEN

Move the highlight bar (pointer) to "MODE SET" by pressing **PUSH JOG** Δ / ∇ , then press **OK**.

4 ENABLE/DISABLE ON-SCREEN DISPLAY

The default setting is "ON", so if you want on-screen displays, leave the setting as it is and go to step 5. If you don't want the displays to appear, press **PUSH JOG** Δ / ∇ to move the highlight bar (pointer) to "O.S.D." and press **PUSH JOG** \triangleright to set "O.S.D." to "OFF".

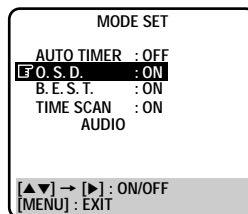

5 RETURN TO NORMAL

Press **MENU**.

NOTES:

- When you use this recorder as the player for editing, be sure to set "O.S.D." to "OFF" before starting.
- During playback, the operation mode indicators may be disturbed depending on the type of tape being used.

The superimposed indication on the TV screen tells you what the recorder is doing.

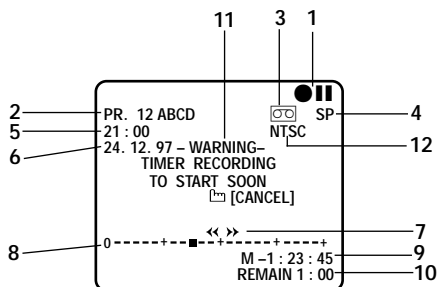

- 1- Operation mode indicators
- 2- Preset position number and station name/Aux. indicator (AUX1 or AUX2)
- 3- Cassette loaded mark
- 4- Tape speed SP/LP/EP (EP is for NTSC playback only)
- 5- Clock display
- 6- Current day/month/year
- 7- Tape direction
- 8- Tape position indicator (ⓘ pg. 33)
- 9- Counter display (including Counter Memory indicator)
- 10- Tape remaining time indicator (ⓘ pg. 19)
- 11- Timer warning display (ⓘ pg. 26)
- 12- NTSC display (ⓘ pg. 15)

Tape Position Indicator

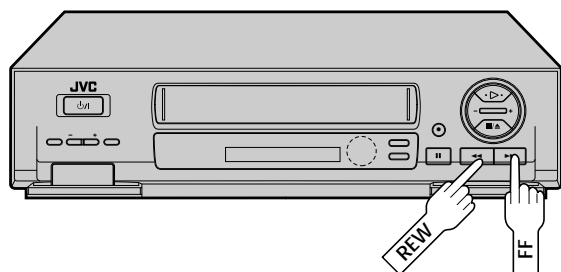

The tape position indicator appears on screen when, from the Stop mode, you press FF, REW or perform an Index Search. The position of "■" in relation to "0" (beginning) or "+" (end) shows you where you are on the tape.

"O.S.D." (pg. 32) must be set to "ON", or the indicator will not appear.

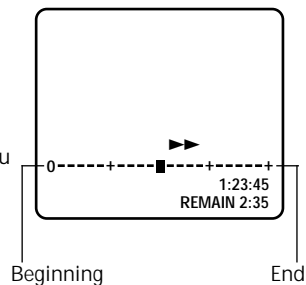

NOTE:

Depending on the type of tape used, there may be times when the indication is not correct.

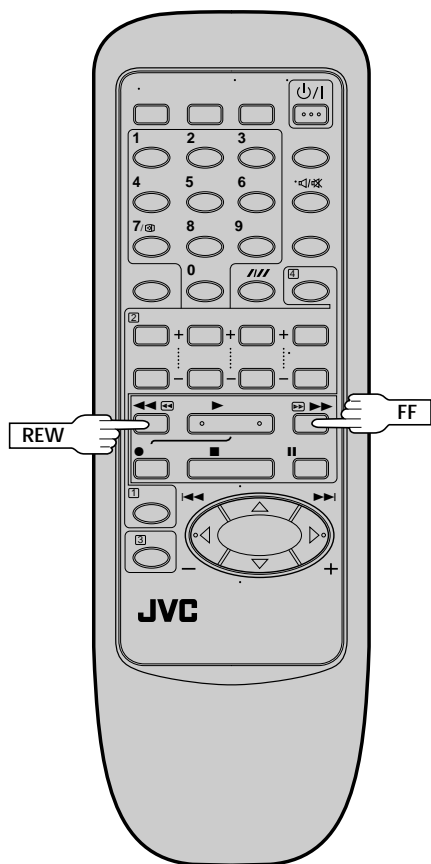

Auto Channel Set

Turn on the TV and select the VIDEO channel (or AV mode).

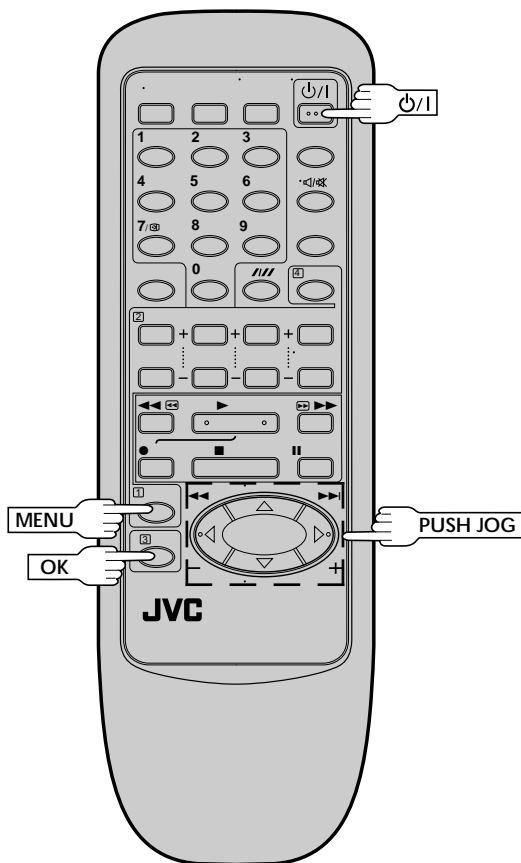

IMPORTANT

Perform the following steps only if auto channel set has not been set correctly by Auto Set Up function (pg. 8) or if you have moved to a different area or if a new station starts broadcasting in your area.

Your recorder needs to memorise all necessary stations in preset positions in order to record TV programmes. Auto Channel Set automatically assigns all receivable stations in your area.

TURN ON THE RECORDER

1

Press **Power/Standby**.

ACCESS MAIN MENU SCREEN

2

Press **MENU** twice.

PERFORM AUTO CHANNEL SET

3

Move the highlight bar (pointer) to "AUTO CH SET" by pressing **PUSH JOG** Δ / ∇ , then press **OK**.

- The Auto Set screen appears, and remains on screen while the recorder searches for receivable stations. As Auto Channel Set progresses, the "■" mark on the screen moves from left to right. Wait until the screen as shown in step 4 appears.
- Auto Channel Set usually takes about 4 – 12 minutes; the duration differs by the area.

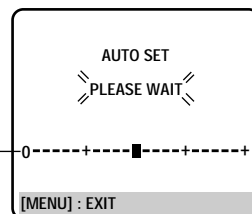
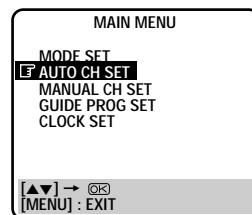

Beginning

End

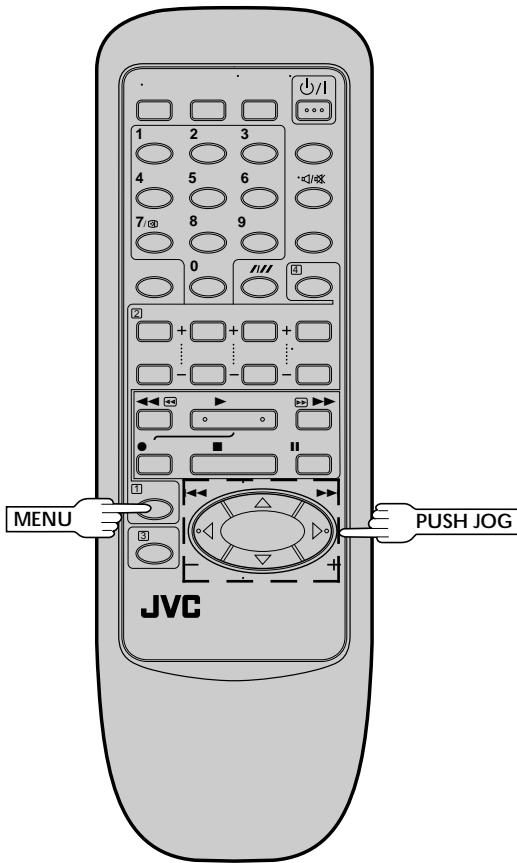

4

VIEW CONFIRMATION SCREEN

The stations your recorder located appear on a Confirmation screen — preset positions (PR), channels (CH) and station names (ID — pg. 40). To view the next page of the listing, press **PUSH JOG** $\Delta \nabla \triangleleft \triangleright$. The blueback screen and the program currently being broadcast by the blinking station appear alternately for 5 seconds each.

PR	CH	ID	PR	CH	ID
01	26	BBC1	08	----	----
02	33	BBC2	09	----	----
03	23	ITV	10	----	----
04	30	CH4	11	----	----
05	37	CH5	12	----	----
06	----	----	13	----	----
07	----	----	14	----	----

$\left[\blacktriangle \blacktriangledown \blacktriangleleft \blacktriangleright \right]$
 \rightarrow $\left[\text{EDIT} \right]$: EDIT
 \rightarrow $\left[\text{CANCEL} \right]$: DELETE
 $\left[\text{MENU} \right]$: EXIT

- The Guide Program numbers will also be set automatically during Auto channel Set.

RETURN TO NORMAL SCREEN

Press **MENU**.

5

- Using the Confirmation screen, you can skip or add preset positions, enter station names and perform other operations. Refer to pages 36 – 39 for the procedures.
- Depending on reception conditions, the stations may not be stored in order, and the station names may not be stored correctly.

IMPORTANT

- Depending on the reception conditions, the station names may not be stored correctly, and auto Guide Program Number Set may not work properly. If the Guide Program numbers are not set properly, Video Plus+ timer recording (pg. 22) will not work correctly; be sure to check if the Guide Program numbers have been set correctly (pg.10, "Video Plus+ Setup").
- Since your video recorder memorizes all detected stations even if the reception condition is poor, some of those stored stations may produce a noisy picture. To delete those stations, $\left[\text{Delete A Channel} \right]$ on page 37.

NOTE:

Fine tuning is performed automatically during Auto Channel Set. If you want to perform it manually, refer to page 39.

Manual Channel Set

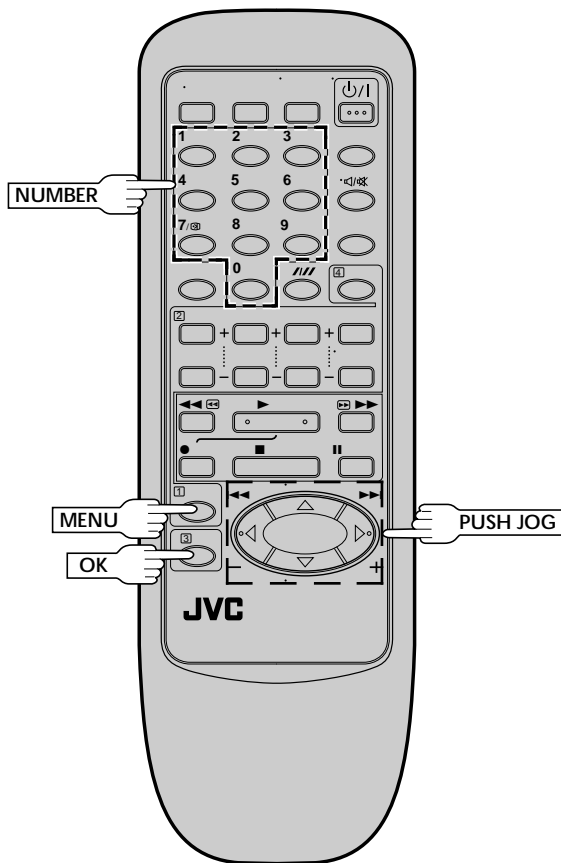

ATTENTION

After you have stored channels manually, be sure to perform Guide Program Number Set (pg. 10) in order to get proper results from Video Plus+ timer recording.

Storing Channels Manually

Store channels that were not stored during Auto Set Up (pg. 8) or Auto Channel Set (pg. 34).

1 ACCESS MAIN MENU

Press **MENU** twice.

2 ACCESS CONFIRMATION SCREEN

Press **PUSH JOG** $\Delta \nabla$ to move the highlight bar (pointer) to "MANUAL CH SET", then press **OK**. The Confirmation screen appears.

3 SELECT POSITION

Press **PUSH JOG** $\Delta \nabla \leftarrow \rightarrow$ until an open position in which you want to store a channel begins blinking, then press **OK**. The Manual Ch. Set screen appears.

4 INPUT CHANNEL

The number "21" appears blinking to the right of "CH". Press the **NUMBER** keys to input the channel number you want to store.

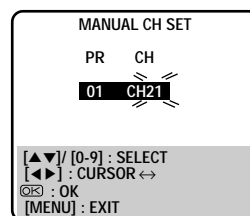

- For fine tuning adjustment, press **PUSH JOG** $\Delta \nabla$ until the channel number begins blinking, then press **PUSH JOG** $\Delta \nabla$. While tuning, "F+" or "F-" appears.

5 ENTER NEW CHANNEL INFORMATION

Press **OK** and the Confirmation screen appears.

- Repeat steps 3 through 5 as necessary.

6 CLOSE CONFIRMATION SCREEN

Press **MENU**.

- To input the station name, see page 38.
- To change positions, see "Change Station Preset Position" (pg. 37).

Perform steps 1 and 2 of "Storing Channels Manually" on page 36 to access the Confirmation screen before continuing.

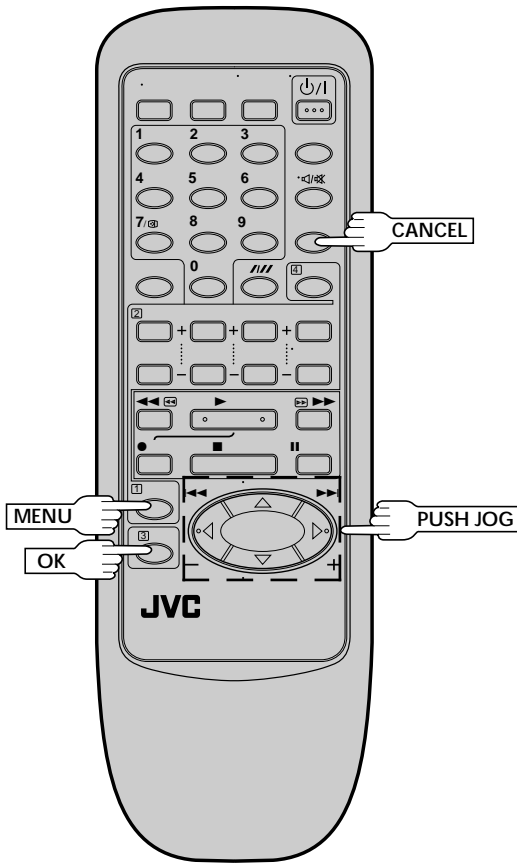

ATTENTION

After you have deleted channels or changed preset positions, be sure to perform Guide Program Number Set (pg. 10) in order to proper results from Video Plus+ timer recording.

Delete A Channel

1 SELECT ITEM

Press **PUSH JOG** $\Delta \nabla \triangleleft \triangleright$ until the item you want to delete begins blinking.

2 DELETE CHANNEL

Press **CANCEL**.

- The item directly beneath the cancelled one moves up one line.
- Repeat steps 1 and 2 as necessary.

3 CLOSE CONFIRMATION SCREEN

Press **MENU**.

Change Station Preset Position

1 SELECT ITEM

Press **PUSH JOG** $\Delta \nabla \triangleleft \triangleright$ until the item you want to move begins blinking. Then press **OK** and the station name (ID) and its channel (CH) number begin blinking.

2 SELECT NEW POSITION

Press **PUSH JOG** $\Delta \nabla \triangleleft \triangleright$ to move the station to the new preset position, then press **OK**.

Example: If you moved the station in position 3 to position 7, the stations originally in positions 4-7 each move up one space.

- Repeat steps 1 and 2 as necessary.

3 CLOSE CONFIRMATION SCREEN

Press **MENU**.

Perform steps 1 and 2 of "Storing Channels Manually" on page 36 to access the Confirmation screen before continuing.

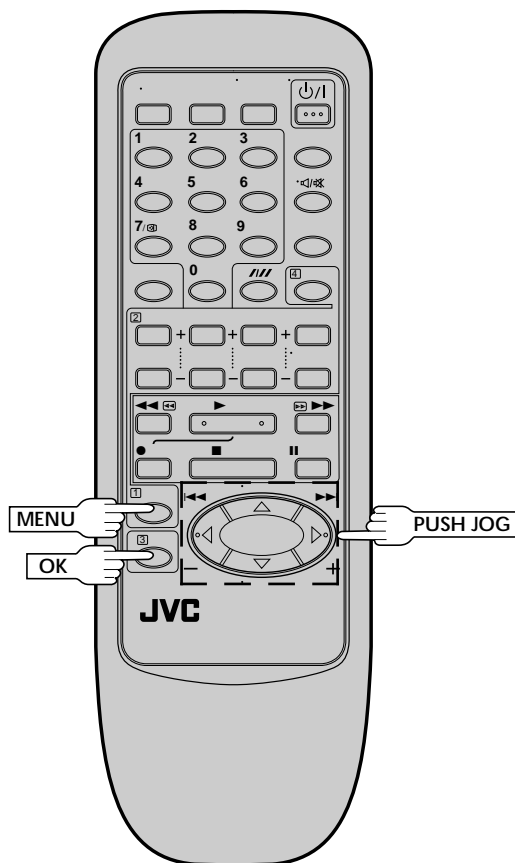

Set Stations (A)

1 SELECT ITEM

Press **PUSH JOG** $\Delta \nabla < \triangleright$ until the item you want begins blinking. Then press **OK** twice and the station's name (ID) begins blinking.

2 SELECT NEW STATION

Press **PUSH JOG** $\Delta \nabla$ until the new station's name (ID) you want to store begins blinking. Registered station names (see pg. 40) appear as you press **PUSH JOG** $\Delta \nabla$.

3 SWITCH STATIONS

Press **OK**.

- Repeat steps 1 through 3 as necessary.

4 CLOSE CONFIRMATION SCREEN

Press **MENU**.

Set Stations (B)

NOTE:

First perform step 1 of the above procedure.

2 SELECT STATION NAME CHARACTER

Press **PUSH JOG** \triangleright and the first letter of the station name begins blinking.

3 ENTER NEW CHARACTER

Press **PUSH JOG** $\Delta \nabla$ to cycle through the characters (A-Z, 0-9, -, *, +, _ (space)) and stop when the desired one is indicated, then press **PUSH JOG** \triangleright to enter. Enter the remaining characters the same way (maximum of 4).

After entering all characters, press **OK**.

- Repeat steps 1 through 3 as necessary.
- If you make a mistake, press **PUSH JOG** $<$ until the incorrect character begins blinking. Then enter the correct character by pressing **PUSH JOG** $\Delta \nabla$.

4 CLOSE CONFIRMATION SCREEN

Press **MENU**.

Perform steps 1 and 2 of "Storing Channels Manually" on page 36 to access the Confirmation screen before continuing.

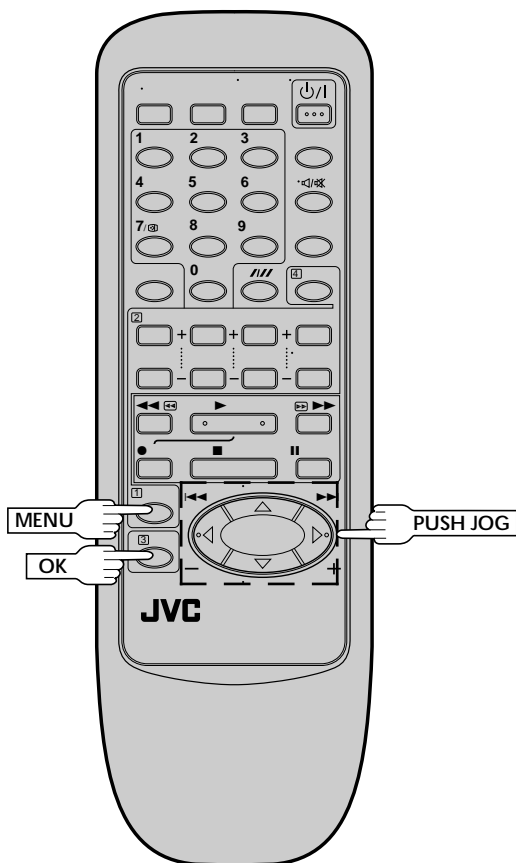

Fine-Tuning Channels Already Stored

1 SELECT CHANNEL TO FINE-TUNE

Press **PUSH JOG** $\Delta \nabla \triangleleft \triangleright$ until the channel you want to tune begins blinking.

2 ACCESS MANUAL CH. SET SCREEN

Press **OK** three times. The Manual Ch. Set screen appears.

3 PERFORM TUNING

Press **PUSH JOG** $\Delta \nabla$ until the picture is its clearest. Then press **OK**.

- The Confirmation screen appears.
- Repeat steps 1 through 3 as necessary.

4 CLOSE CONFIRMATION SCREEN

Press **MENU**.

TV Station And ID List

STATION NAME	ID*
Anglia TV	ANGL
ARD	ARD
ARTE	ARTE
BBC Group	BBC
BBC1	BBC1
BBC2	BBC2
Berlin 1	BLN1
Berlin 2	BLN2
Border TV	BORD
Bayern1	BR1
Bayern3	BR3
BRT1	BRT1
BRT2	BRT2
Children Ch	CHLD
Canal +	CH+
CNN	CNN
Channel TV	CHNL
Central TV	CNTR
Channel 4	CH 4
Channel 5	CH 5
DRS	DRS
DR TV	DRTV
DSF	DSF
Euronews	EURN
Euronews	EURO
Eurosports	EURS
France1	FR1
France2	FR2
France3	FR3
Granada TV	GRNA
Grampian TV	GRMP
Hessen1	HR1
Hessen3	HR3
HRT	HRT
HTV	HTV
ITV Network	ITV
Kabelkanal	KABL
London	LNDN
MDR	MDR
MTV	MTV
Nord3	N3
NDR1	NDR1
NDR3	NDR3
NED1	NED1
NED2	NED2
NED3	NED3
Network 2	NET2
NRK	NRK
N-TV	N-TV
Offener Kanal	OKAN
ORF1	ORF1
ORF2	ORF2
ORF3	ORF3
OWL 3	OWL3
Premiere	PRMI
PR07	PR07
RAI1	RAI1
RAI2	RAI2
RAI3	RAI3
RB1	RB1
RB3	RB3
Rikisutvarpid-S	RKPS
RTBF 1	RTB1
RTBF 2	RTB2
RTE 1	RTE1
RTL	RTL
RTL 2	RTL2
RTP	RTP

STATION NAME	ID*
SAT	
SAT 1	SAT1
Scottish TV	SCOT
SC4	SC4
SDR	SDR
SDR1	SDR1
SFB1	SFB1
SFB3	SFB3
SKY	
Sky One	SKY1
Sky Net	SKYN
Sport	SPRT
SR 1	SR1
Super RTL	SRTL
STV Test	STVT
STV 1	STV1
STV 2	STV2
Suedwest3	SW3
SWF 1	SWF1
Schweiz4	SWZ4
TYNE TEES	TEES
Text	TEXT
TF1	TF1
TNT int	TNT
TRT int	TRT
TSI	TSI
TSR	TSR
TSW	TSW
TVE	TVE
TV Polonia	TVPA
TVP 1	TVP1
TVP 2	TVP2
TVS	TVS
TV2	TV2
TV5	TV5
Tele Zurich	TZUR
Ulster TV	ULST
Veronica	VERN
VIVA	VIVA
VIVA2	VIV2
VOX	VOX
VTM	VTM
VT4	VT4
West1	WDR1
West3	WDR3
YLE 1	YLE1
YLE 2	YLE2
Yorkshire TV	YORK
ZDF	ZDF
Zurich 1	ZUR1
3SAT	3SAT

* The "ID" abbreviation is what is shown on-screen in lieu of the station name. The "ID" abbreviation is listed in the Confirmation screen and is displayed on the TV screen when the recorder is tuned to a different station.

TV Station Channel Number Guide

Only the main stations are listed. There are in addition many relay stations, and full lists are available from BBC and ITC.

	BBC1	BBC2	ITV	CH4		BBC1	BBC2	ITV	CH4
London & South-East					North-West				
Bluebell Hill	40	46	43	65	Caldbeck	30	34	28	32
Crystal Palace	26	33	23	30	Winter Hill	55	62	59	65
Dover	50	56	66	53	North-East				
Heathfield	49	52	64	67	Bilsdale West Moor	33	26	29	23
Oxford	57	63	60	53	Chatton	39	45	49	42
South-West					Pontop Pike	58	64	61	54
Beacon Hill	57	63	60	53	Scotland				
Caradon Hill	22	28	25	32	Angus	57	63	60	53
Huntshaw Cross	55	62	59	65	Black Hill	40	46	43	50
Redruth	51	44	41	47	Sandale	22	—	—	—
Stockland Hill	33	26	23	29	Caldbeck	—	34	28	32
Channel Islands					Creigkelly	31	27	24	21
Fremont Point	51	44	41	47	Darvel	33	26	23	29
South					Durris	22	28	25	32
Hannington	39	45	42	66	Eitshal	33	26	23	29
Midhurst	61	55	58	68	Keelylang Hill	40	46	43	50
Rowridge	31	24	27	21	Knock More	33	26	23	29
West					Rosemarkie	39	45	49	42
Mendip	58	64	61	54	Rumster Forest	31	27	24	21
East					Selkirk	55	62	59	65
Sandy Heath	31	27	24	21	Wales				
Sudbury	51	44	41	47	Blaenplwyf	31	27	24	21
Tacolneston	62	55	59	65	Carmel	57	63	60	53
Midlands					Llanddona	57	63	60	53
Ridge Hill	22	28	25	32	Moel-y-Parc	52	45	49	42
Sutton Coldfield	46	40	43	50	Presely	46	40	43	50
The Wrekin	26	33	23	29	Wenvoe	44	51	41	47
Waltham	58	64	61	54	Northern Ireland				
North					Brougher Mountain	22	28	25	32
Belmont	22	28	25	32	Divis	31	27	24	21
Emley Moor	44	51	47	41	Limavady	55	62	59	65

Clock Set

Turn on the TV and select the VIDEO channel (or AV mode).

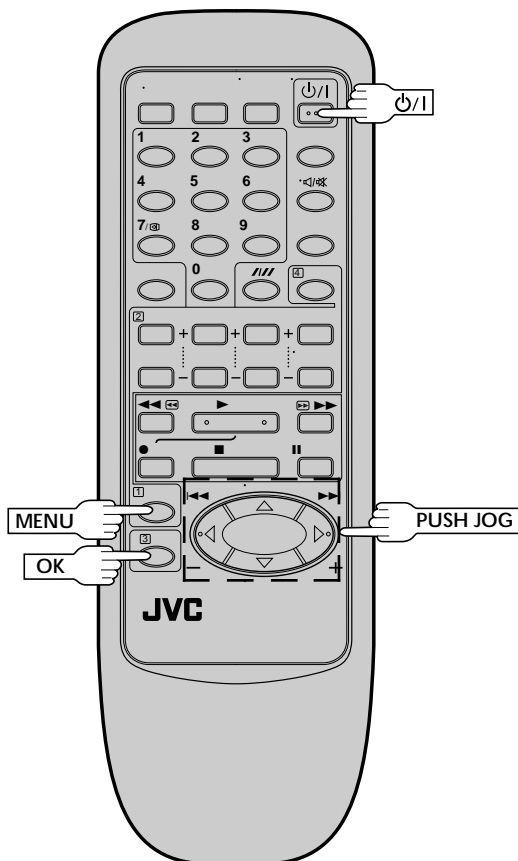

IMPORTANT

Perform the following steps only if Auto Clock Set has not been performed correctly by Auto Set Up (pg. 8) or Auto Channel Set (pg. 34) or if the recorder's memory backup has expired.

If you performed Auto Set Up or Auto Channel Set without ever having set the clock previously, the recorder's built-in clock is also set automatically. The Auto and Manual clock setting procedures are necessary when . . .

- a power outage of more than 3 minutes occurs.
- the tuner has been set manually.
- the user desires to set the clock slightly ahead of the actual time.
- the clock was not set even after Auto Set Up or Auto Channel Set was performed.

Whether you perform Auto or Manual clock setting, you can use the convenient Just Clock function.

Just Clock

The Just Clock function provides accurate time keeping through automatic adjustments at regular intervals, by reading data from a PDC signal.

The Just Clock option appears in the Clock Set and Auto Clock Set screens, and can be set "ON" or "OFF" (the default setting is "ON"). Press **OK** until the Just Clock setting begins blinking, then press **PUSH JOG** to change the setting.

IMPORTANT: If you turn off Just Clock off, the accuracy of your recorder's built-in clock may be reduced, which could adversely effect timer recording.

Both Auto and Manual clock setting procedures begin from step 4.

Preparation

1 TURN THE RECORDER ON

Press **power**.

2 ACCESS MAIN MENU SCREEN

Press **MENU** twice.

3 ACCESS CLOCK SET SCREEN

Move the highlight bar (pointer) to "CLOCK SET" by pressing **PUSH JOG** $\Delta \nabla$, then press **OK**. The Clock Set screen appears.

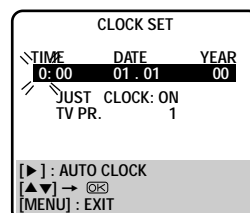
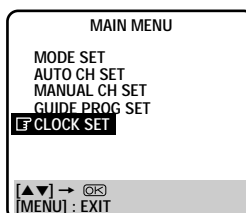

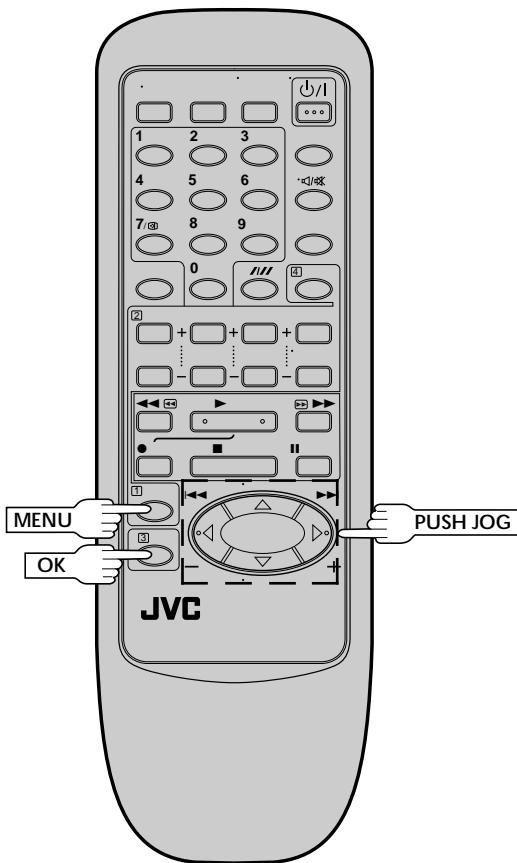

Auto Clock Set

4

SET CLOCK AUTOMATICALLY

At the Clock Set screen, press **PUSH JOG** \blacktriangleright . The Auto Clock Set screen appears and clock setting begins.

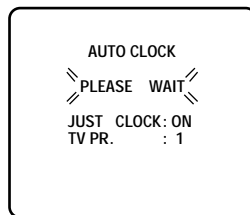

- If "TV PR." isn't set to the preset position on which Auto Clock Set data is received, "ERROR" appears, and then the screen from step 3 reappears. To set "TV PR.", press **OK** to place the cursor next to it, then cycle through the numbers by pressing **PUSH JOG** \blacktriangle \blacktriangledown until the number representing the position in which the station transmitting clock setting data (BBC1, BBC2, etc.) is stored appears.

5

RETURN TO NORMAL SCREEN

Once clock setting is completed, press **MENU** to return to the normal screen.

Manual Clock Set

4

SET DATE AND TIME

Press **PUSH JOG** \blacktriangle \blacktriangledown to set the hour, then press **OK**. The "minutes" display begins blinking. Repeat the procedure to set the minutes, day, month and year.

5

SET JUST CLOCK

The default setting is "ON". Set as desired by pressing **PUSH JOG** \blacktriangle \blacktriangledown , then press **OK**.

- If you set to "OFF", you can disregard the next step as you won't be able to receive regular clock adjustments.

6

SET CLOCK DATA SOURCE PRESET

The recorder is preset to receive clock setting and adjustment data from preset position 1. Press **PUSH JOG** \blacktriangle \blacktriangledown to set the preset position to the number representing the station transmitting clock setting data (BBC1, BBC2, etc.), then press **OK**.

7

START CLOCK OPERATION

Press **MENU**.

NOTES:

- *Just Clock* (when set to "ON") adjusts the recorder's built-in clock every hour, except for 23:00, 0:00, 1:00 and 2:00.
- *Just Clock* is not effective when . . .
 - the recorder's power is on (unless the recorder is tuned to the same preset selected in the Clock Set screen).
 - the recorder is in the Timer mode.
 - a difference of more than 3 minutes exists between the built-in clock's time and the actual time.
- If *Just Clock* is set to "ON", the recorder's clock is automatically adjusted at the start/end of Summer Time.
- Auto clock setting and *Just Clock* may not function properly depending on the reception condition.
- During Manual clock setting, if the day and month data are invalid (such as 31st April), the month digits are cleared automatically and the day digits begin blinking. Input the correct data.
- If, in step 4 of the Manual clock setting procedure, the year digits are automatically cleared and the day digits begin blinking, it is possible that you have input 29th February for a non-leap year. Input the correct data.

Before requesting service for a problem, use this chart and see if you can repair the trouble yourself. Small problems are often easily corrected, and this can save you the trouble of sending your video recorder off for repair.

POWER

SYMPTOM	POSSIBLE CAUSE	CORRECTIVE ACTION
1. No power is applied to the recorder.	<ul style="list-style-type: none"> The mains power cord is disconnected. 	Connect the mains power cord.
2. The clock is functioning properly, but the recorder cannot be powered.	<ul style="list-style-type: none"> "⊖" is displayed on the display panel with Auto Timer set to "OFF". 	Press the TIMER button to turn the "⊖" indicator off.

TAPE TRANSPORT

SYMPTOM	POSSIBLE CAUSE	CORRECTIVE ACTION
1. The tape does not run during recording.	<ul style="list-style-type: none"> "□□" is displayed on the display panel. 	Press PLAY to turn the "□□" indicator off.
2. The tape stops during rewind or fast-forward.	<ul style="list-style-type: none"> "M" is displayed on the display panel. 	Press C.MEMORY to deactivate the Counter Memory function and turn the "M" indicator off.
3. The tape will not rewind or fast-forward.	<ul style="list-style-type: none"> The tape is already fully rewound or fast-forwarded. 	Check the cassette.

PLAYBACK

SYMPTOM	POSSIBLE CAUSE	CORRECTIVE ACTION
1. The playback picture does not appear while the tape is running.	<ul style="list-style-type: none"> If you're using the RF OUT connection the TV receiver's channel selector is not set to the VIDEO channel. the recorder's VIDEO channel has not been correctly set. If you're using the AV connection, the TV receiver is not set to the AV mode. 	<p>If you are using the RF OUT connection set the TV receiver to the VIDEO channel. (☞ pg. 6)</p> <p>. . . Perform "Video Channel Set" (☞ pg. 6)</p> <p>If you are using the AV connection, set the TV to its AV mode.</p>
2. Noise appears during normal playback.	<ul style="list-style-type: none"> The automatic tracking mode is engaged. 	Try manual tracking. (☞ pg. 14)
3. Noise appears during slow-motion playback.	<ul style="list-style-type: none"> The automatic tracking mode is engaged. 	Try manual tracking. (☞ pg. 14)
4. Noise appears during still playback.		Press TV PROG + or - a few times to remove the noise bars from the screen.
5. The playback picture is blurred or interrupted while TV broadcasts are clear.	<ul style="list-style-type: none"> The video heads may be dirty. 	Consult your JVC dealer.

RECORDING

SYMPTOM	POSSIBLE CAUSE	CORRECTIVE ACTION
1. Recording cannot be started.	<ul style="list-style-type: none"> There is no cassette loaded, or the cassette loaded has had its Record Safety tab removed. 	Insert a cassette, or using adhesive tape, reseal the slot where the tab was removed.
2. TV broadcasts cannot be recorded.	<ul style="list-style-type: none"> "AU" has been selected as the input mode. 	Set to the desired preset.
3. Tape-to-tape editing is not possible.	<ul style="list-style-type: none"> The source (another video recorder, camcorder) has not been properly connected. All necessary power switches have not been turned on. The input mode is not correct. 	<p>Confirm that the source is properly connected.</p> <p>Confirm that all units' power switches are turned on.</p> <p>Set the input mode to "AU".</p>
4. Camcorder recording is not possible.	<ul style="list-style-type: none"> The camcorder has not been properly connected. The input mode is not correct. 	<p>Confirm that the camcorder is properly connected.</p> <p>Set the input mode to "AU".</p>

TIMER RECORDING

SYMPTOM	POSSIBLE CAUSE	CORRECTIVE ACTION
1. Timer recording won't work.	<ul style="list-style-type: none"> • The clock and/or the timer have been set incorrectly. • The timer is not engaged. 	Re-perform the clock and/or timer settings. Press TIMER and confirm that "⊖" is displayed on the display panel.
2. On-screen timer programming is not possible.	<ul style="list-style-type: none"> • Timer recording is in progress. 	Timer programming can't be performed while a timer recording is in progress. Wait until it finishes.
3. "⊖" and "⊞" on the display panel won't stop blinking.	<ul style="list-style-type: none"> • The timer is engaged but there's no cassette loaded. 	Load a cassette with the Record Safety tab intact, or cover the hole using adhesive tape.
4. The cassette is automatically ejected, and "⊖" and "⊞" on the display panel won't stop blinking.	<ul style="list-style-type: none"> • The loaded cassette has had its Record Safety tab removed. 	Remove the cassette and cover the hole with adhesive tape, or insert a cassette with the Record Safety tab intact.
5. "⊖" blinks for 10 seconds and the Timer mode is disengaged.	<ul style="list-style-type: none"> • TIMER has been pressed when there are no programs in memory, or the timer record information has been programmed incorrectly. 	Check the programmed data and re-program as necessary, then press TIMER again.
6. The cassette is automatically ejected, the power shuts off and "⊖" and "⊞" won't stop blinking.	<ul style="list-style-type: none"> • The end of the tape was reached during timer recording. 	The programme may not have been recorded in its entirety. Next time make sure you have enough time on the tape to record the entire programme.
7. Video Plus+ does not timer-record properly.	<ul style="list-style-type: none"> • The recorder's preset positions have been set incorrectly. 	Refer to "Guide Program Number Set" and re-perform the procedure (Ⓛ pg. 10).

OTHER PROBLEMS

SYMPTOM	POSSIBLE CAUSE	CORRECTIVE ACTION
1. Whistling or howling is heard from the TV during camcorder recording.	<ul style="list-style-type: none"> • The camcorder's microphone is too close to the TV. • The TV's volume is too high. 	Position the camcorder so its microphone is away from the TV. Turn the TV's volume down.
2. When scanning channels, some of them are skipped over.	<ul style="list-style-type: none"> • Those channels have been designated to be skipped. 	If you need the skipped channels, restore them (Ⓛ pg. 36).
3. The preset cannot be changed.	<ul style="list-style-type: none"> • Recording is in progress. 	Press PAUSE to pause the recording, change presets, then press PLAY to resume recording.
4. Channel settings that were made manually seem to have changed or disappeared.	<ul style="list-style-type: none"> • After the manual settings were made, Auto Channel Set was performed. 	Perform manual setting again.
5. No channels are stored in the recorder's memory.	<ul style="list-style-type: none"> • The TV aerial cable was not connected to the recorder when Auto Set Up was performed. 	Connect the TV aerial cable to the recorder properly and turn off the recorder power once, then turn the recorder power back on again. The recorder will try Auto Set Up again (Ⓛ pg. 8).

PLAYBACK

- Q. What happens if the end of the tape is reached during playback or search?**
A. The tape is automatically rewound to the beginning.

- Q. Can the video recorder indefinitely remain in the still mode?**
A. No. It stops automatically after 5 minutes to protect the heads.

- Q. When returning from multi-speed search to normal playback, the picture is disturbed. Should I be concerned about this?**
A. No, it is normal.

- Q. Other than preventing further recording, what effect does removing the Record Safety tab have?**
A. It disables marking of index codes.

- Q. Sometimes, during Index Search, the video recorder can't find the programme I want to see. Why not?**
A. There may be index codes too close together.

RECORDING

- Q. When I pause and then resume a recording, the end of the recording before the pause is overlapped by the beginning of the continuation of recording. Why does this happen?**
A. This is normal. It reduces distortion at the pause and resume points.

- Q. Can the video recorder indefinitely remain in the Record-Pause mode?**
A. No. The video recorder shuts off automatically after 5 minutes to protect the heads.

- Q. What happens if the tape runs out during recording?**
A. The video recorder automatically rewinds it to the beginning.

TIMER RECORDING

- Q. "O" and "⊖" remain lit on the display panel. Is there a problem?**
A. No. This is a normal condition for a timer recording in progress.

- Q. Can I program the timer while I'm watching a tape or a TV broadcast?**
A. You won't see the picture as it is replaced by the on-screen menu, but the audio from the program or tape you're viewing can be heard.

ATTENTION:

This recorder contains microcomputers. External electronic noise or interference could cause malfunctioning. In such cases, switch the recorder off and unplug the mains power cord. Then plug it in again and turn the recorder on. Take out the cassette. After checking the cassette, operate the unit as usual.

GENERAL

Power requirement	: AC 220 – 240 V~, 50/60 Hz
Power consumption	: 20 W
Temperature	
Operating	: 5°C to 40°C
Storage	: -20°C to 60°C
Operating position	: Horizontal only
Dimensions (WxHxD)	: 400 x 94 x 340 mm
Weight	: 4.3 kg
Format	: VHS PAL standard
Maximum recording time	
(SP)	: 240 min. with E-240 video cassette
(LP)	: 480 min. with E-240 video cassette

VIDEO/AUDIO

Signal system	: PAL-type colour signal and CCIR monochrome signal, 625 lines/50 fields
Recording system	: DA4 (Double Azimuth) helical scan system
Signal-to-noise ratio	: 45 dB
Horizontal resolution	: 250 lines
Frequency range	: 70 Hz to 10,000 Hz
Input/Output	: 21-pin scart connector x 2 (IN/OUT x 1, IN x 1)

TUNER/TIMER

TV channel storage capacity	: 99 positions (+AUX position "AU")
Tuning system	: Frequency synthesized tuner
Channel coverage	: UHF channels 21 – 69 (470 – 862 MHz)
Aerial output	: UHF channels 22 – 69 (Adjustable)
Memory backup time	: Approx. 3 min.

ACCESSORIES

Provided accessories	: RF cable, Infrared remote control unit, "AA" battery x 2
----------------------	--

Specifications shown are for SP mode unless otherwise specified.

E. & O.E. Design and specifications subject to change without notice.

FRONT VIEW

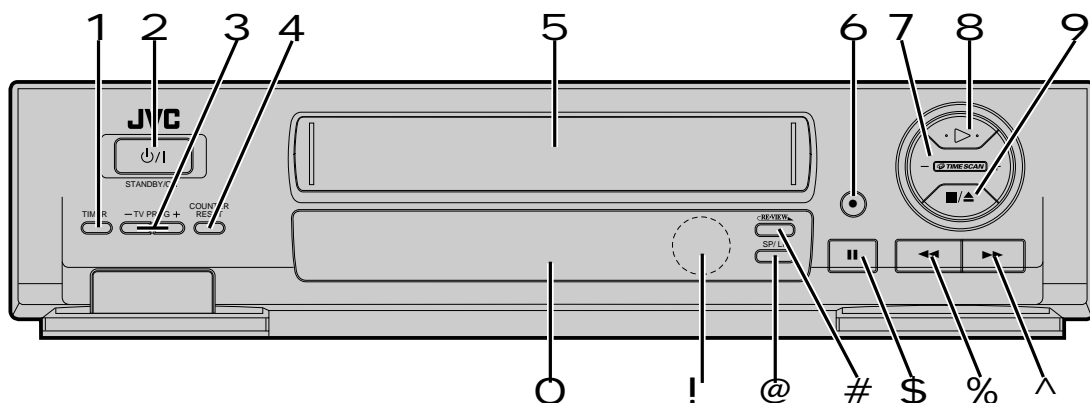

- 1 **TIMER Button** engages timer standby mode. ☞ pg. 23, 25
- 2 **STANDBY/ON** ⏻ **Button** turns recorder on/off (loading a cassette also turns power on). ☞ pg. 8
- 3 **TV PROG +/- Buttons** select a preset position. ☞ pg. 18
- 4 **COUNTER RESET Button** resets counter to 0:00:00. ☞ pg. 19
- 5 **Cassette Loading Slot** is where cassette is inserted; door closes, "cassette loaded" indicator lights up on front display panel.
- 6 **RECORD Button** starts regular recording (press once), Instant Timer Recording (press twice); sets duration of ITR. ☞ pg. 18, 19
- 7 **TIME SCAN Button** initiates frame by frame playback; ☞ pg. 13, variable-speed search ☞ pg. 16.
- 8 **PLAY Button** plays back tape ☞ pg. 12; cancels Pause, Still, Slow, Search modes. ☞ pg. 13, 16
- 9 **STOP/EJECT Button** stops tape; ejects tape during Stop mode. ☞ pg. 12
- O **Display Panel** provides clear view of various displays and indicators. ☞ pg. 49
- ! **Infrared Beam Receiving Window** is where remote control should be aimed when in use.
- @ **SP/LP Button** selects tape speed. ☞ pg. 18
- # **REVIEW Button** "reviews" timer-recorded programme. ☞ pg. 14
- \$ **PAUSE Button** stops tape temporarily during recording ☞ pg. 18; stops tape temporarily during playback; plays back frame by frame with each additional press. ☞ pg. 13
- % **Rewind [REW] Button** rewinds the tape ☞ pg. 12; initiates high-speed reverse search. ☞ pg. 16
- ^ **Fast Forward Button** fast-forwards tape ☞ pg. 12; initiates high-speed forward search. ☞ pg. 16

REAR VIEW

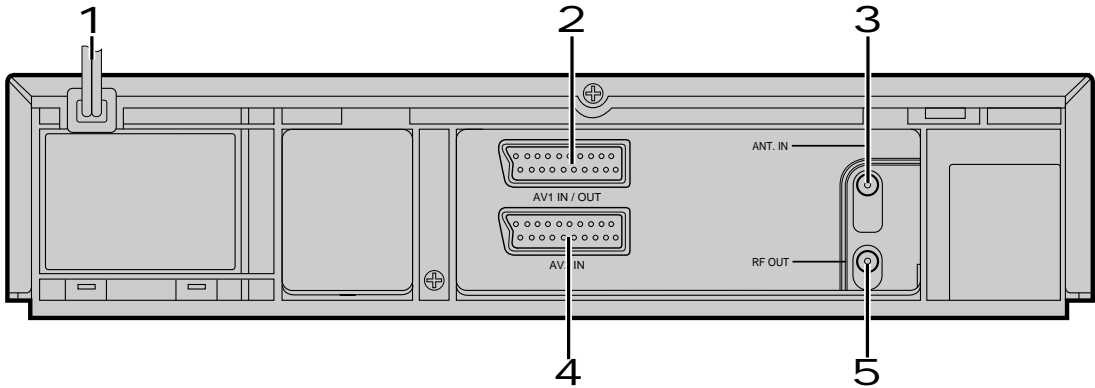

- 1 **Mains Power Cord** supplies power to recorder. [☞ pg. 4](#)
- 2 **AV1 IN/OUT Connector** enables AV connection to TV or second recorder; input recordable when "AU-1" selected. [☞ pg. 4, 28](#)
- 3 **ANT. IN Connector** enables connection of aerial. [☞ pg. 4](#)
- 4 **AV2 IN Connector** enables connection of satellite receiver or second recorder; input recordable when "AU 2" selected. [☞ pg. 30, 28](#)
- 5 **RF OUT Connector** enables connection to aerial terminal of TV receiver. [☞ pg. 4](#)

DISPLAY PANEL

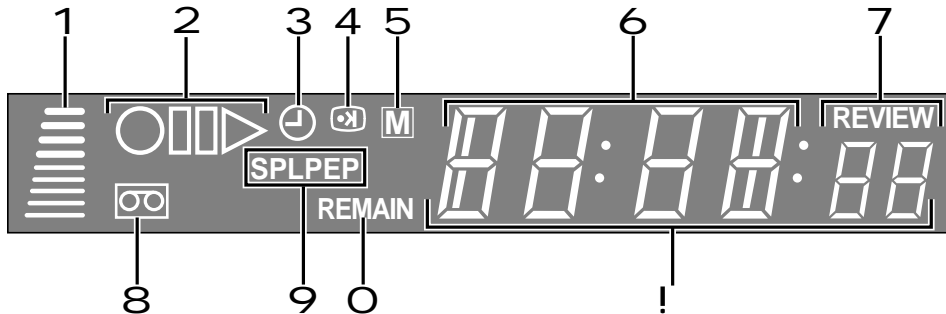

- 1 **B.E.S.T. Picture System Display** lights from bottom to top while B.E.S.T. is active. [☞ pg. 20](#)
- 2 **Symbolic Mode Indicators**

PLAY: FF/REW VARIABLE SHUTTLE SEARCH:	▶	STILL: SLOW:	▢▢▶
		RECORD:	○
		RECORD PAUSE:	○▢▢

- 3 **"Timer" Indicator** lights when TIMER has been pressed to engage Timer mode. [☞ pg. 23, 25](#)
- 4 **PDC Indicator** lights when PDC has been engaged for timer recording. [☞ pg. 22, 24](#)
- 5 **Counter Memory Indicator** lights when the video recorder is in the Counter Memory mode. [☞ pg. 15](#)
- 6 **Channel Display** shows preset position where the station currently being received is stored. (Ex.) Preset position 1 will be displayed as "CH 1". **Mode** shows external input mode selected. **Clock Display** shows current time. [☞ pg. 9, 42](#)

- 7 **Instant REVIEW Indicator** blinks after timer-recording and shows how many programmes have been timer-recorded. [☞ pg. 14](#)
- 8 **"Cassette Loaded" Mark** lights once a cassette is inserted; remains lit until cassette ejected or power turned off.
- 9 **Tape Speed Indicators** display mode of recording; light during Record or Play mode. [☞ pg. 18](#)
* EP is for NTSC playback only.
- **Tape Remaining Time Indicator** displays time remaining on tape when certain buttons are pressed. [☞ pg. 19](#)
- ! **Counter** shows time elapsed since playback or recording began. **REMAIN** displays time remaining from current tape position to end of tape. Counter, Preset Position*, Clock and REMAIN Display appear alternately when **DISPLAY** is pressed.
**Preset Position is not displayed during playback.*

REMOTE CONTROL

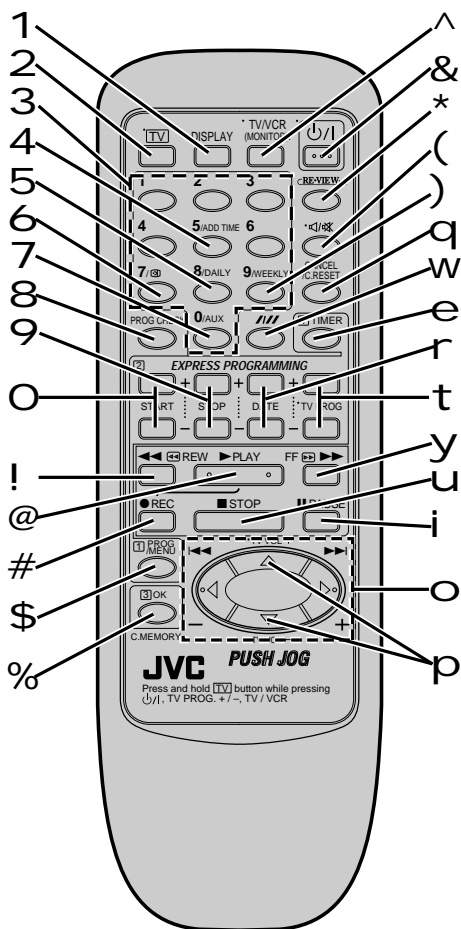

Buttons with a small dot on the left side of the name can also be used to operate your JVC TV while holding down the TV button. ☞ "Operating JVC TVs" on page 51.

- 1 **DISPLAY Button** switches display between clock time, tape remaining time, counter readings, preset position*. ☞ pg. 19
* *Preset position is not displayed during playback.*
- 2 **TV Button** enables remote control of your JVC TV. ☞ "Operating JVC TVs" on page 51.
- 3 **NUMBER Keys** are used in preset position selection ☞ pg. 18, Video Plus+ timer programming ☞ pg. 22.
- 4 **ADD TIME Button** adds time to end of Video Plus+ timer recording (5 minutes each time button is pressed.) ☞ pg. 23
- 5 **DAILY Button** enables timer recording of daily serials. ☞ pg. 23, 25
- 6 **(PDC) Button** enables/disables PDC recording. ☞ pg. 22, 25
- 7 **AUX Button** selects recorder's auxiliary input mode. ☞ pg. 28
- 8 **PROG CHECK Button** accesses Program screens/displays to check the program that you have programmed (next program's information screen/display appears each time button is pressed). ☞ pg. 26
- 9 **STOP +/- Button** inputs programme Stop Time. ☞ pg. 24
- 0 **START +/- Button** accesses Regular Program screen; inputs programme Start Time. ☞ pg. 24
- ! **Rewind [REW] Button** — same as button on recorder. ☞ pg. 12
- @ **Play Button** — same as button on recorder. ☞ pg. 12
- # **Record Button** — same as button on recorder. ☞ pg. 18
- \$ **PROG/MENU Button** accesses Program screen (press once) or Main Menu screen (press twice). ☞ pg. 22, 10
- % **OK Button** enters selections made in on-screen menus. ☞ pg. 10
- C. MEMORY Button** engages Counter Memory mode. ☞ pg. 15
- ^ **TV/VCR Button** switches connected TV's mode between TV and AV. ☞ "Operating JVC TVs" on page 51.
- & **STANDBY/ON Button** — same as button on recorder. ☞ pg. 8
- * **REVIEW Button** "reviews" timer-recorded programme. ☞ pg. 14
- (**(TV Mute) Button** mutes sound of connected TV. ☞ "Operating JVC TVs" on page 51.
-) **WEEKLY Button** enables timer recording of weekly serials. ☞ pg. 23, 25
- q **CANCEL Button** erases previously entered data in on-screen selection menus. ☞ pg. 11
- C. RESET Button** resets counter to 0:00:00. ☞ pg. 19

- w **SP/LP Button** selects tape speed. pg. 18
Auto Tracking Button enables/disables auto tracking mode during playback pg. 14
- e **TIMER Button** — same as button on recorder. pg. 23, 25
- r **DATE +/- Button** inputs date of program for timer recording. pg. 24
- t **TV PROG +/- Button** — same as button on recorder. pg. 18
- y **Fast Forward Button** — same as button on recorder. pg. 12
- u **Stop Button** — same as button on recorder. pg. 12
- i **Pause Button** — same as button on recorder. pg. 13
- o **PUSH JOG $\Delta \nabla \triangleleft \triangleright$ Button** is used for selection in on-screen menus. pg. 10
PUSH JOG $\triangleleft \triangleright$ Button initiates functions such as Index Search pg. 15, variable-speed search, frame by frame playback. pg. 13, 16
- p **TV VOL +/- Button** controls volume of connected TV. "Operating JVC TVs" to the right.

Installing Batteries

- 1 Open the battery compartment cover.
- 2 Insert 2 "AA"-size batteries (provided) in the correct directions.
- 3 Replace the cover.

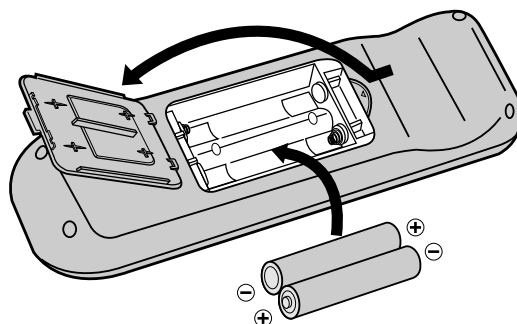

How To Use

The remote control can operate most of your video recorder's functions, as well as basic functions of JVC TV sets. (See below.)

- Point the remote control toward the sensor window.
- The maximum operating distance of the remote control is about 8 m.

Operating JVC TVs

To operate your TV, while holding down **TV**, press the corresponding button: **STANDBY/ON** $\phi/1$, **TV/VCR**, **TV PROG +/-**, **TV VOL +/-**, $\triangleleft/1/\otimes$ (TV Mute).

NOTES:

- Depending on the type of JVC TV, there may be cases where some or all functions cannot be operated using the remote control.
- If for some reason the remote control doesn't work properly, remove its batteries, wait a short time and then try again.

JVC
VICTOR COMPANY OF JAPAN, LIMITED